

aerospace
electromechanical
filtration
fluid & gas handling
hydraulic
instrumentation
pneumatics
process control
sealing & shielding

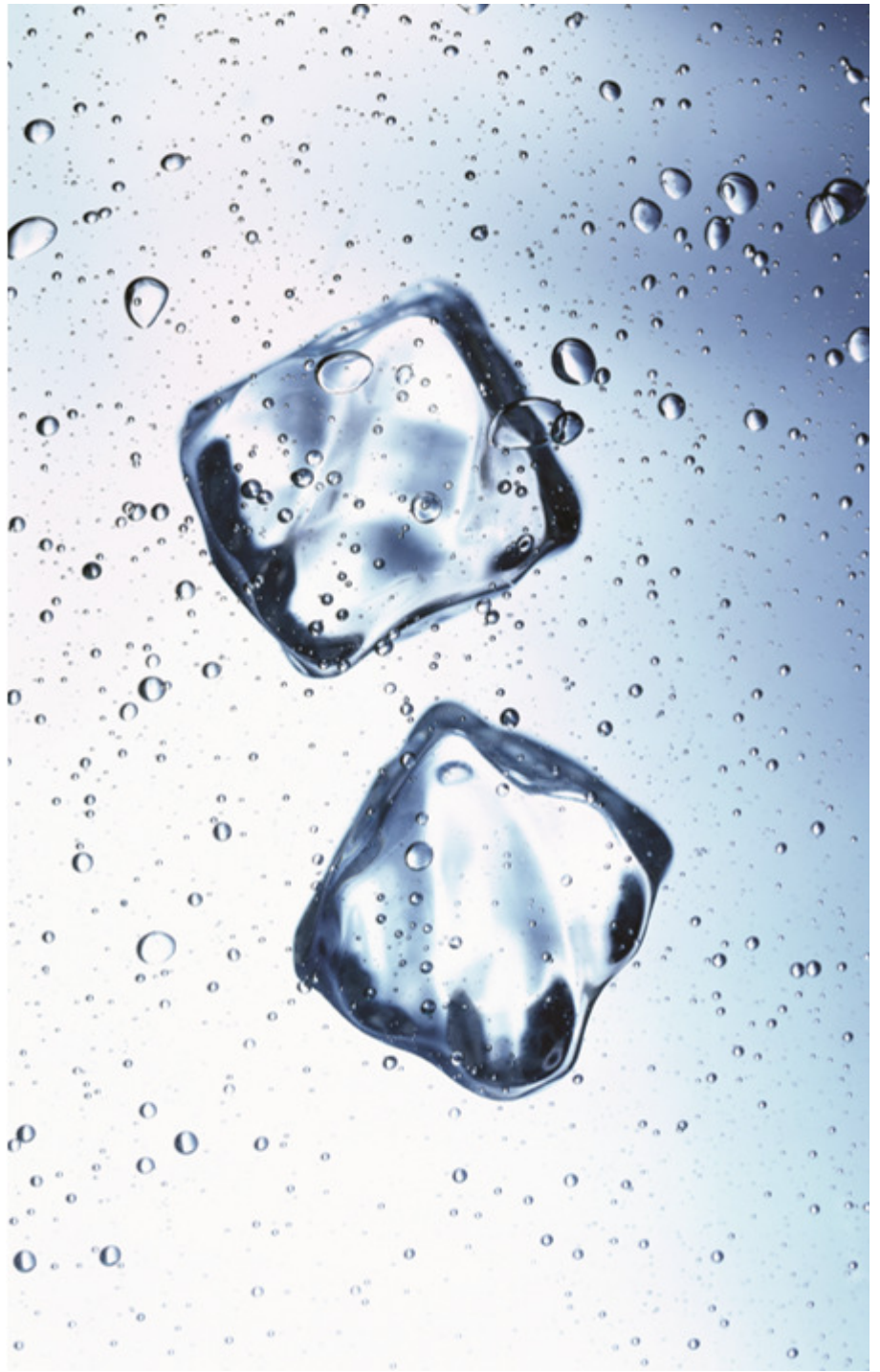

Parker Hannifin GmbH
Industrial Refrigeration Division Europe
Herl International Pricelist
IILP-19 **July 2018**

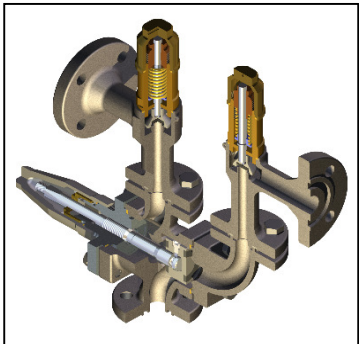
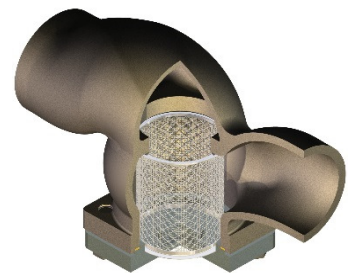

Adresse

Address

Parker Hannifin GmbH
Industrial Refrigeration Division Europe
Pat-Parker-Platz 1
D-41564 Kaarst - Germany
Internet: www.parker.com/refspec

Gültig ab 1. Juli 2018

Valid July, 1st. 2018

Alle Preise freibleibend

All prices are subject to change.

Alle Bilder und technische Angaben unter Vorbehalt.

All pictures and technical informations are under reserve.

ENGINEERING **YOUR** SUCCESS.

Inhalt

Contents

Allgemeine Hinweise		General Information	Seite/Page
Kontakt Liste		Contact List	5
Bestellhinweis		How To Order	6
Wichtige Hinweise		Important Remarks	7
Standard* Ventile, Stahl		Standard* Valves, Steel	Serie
Serviceventile		Service Valves	T34, T37
Serviceventile		Service Valves	T63, T64
Ölablassventil		Oil Drain Valve	T38V.E
Absperrventile		Shut-Off Valves, BW	T5, T6, T5F, T6F
Absperrventile FABA		Shut-Off Valves Bellows	T5F.FA, T6F.FA
Absperrventile CO ²		Shut-Off Valves CO ² , BW	T5F-CO2, T6F-CO2
Kugelventile		Ball Valves	T42, T43
Kugelventile mit Antrieb		Ball Valves with Actuator	T420, T430, T620,
Absperrklappen		Butterfly Valves	T53
Absperrklappen mit Antrieb		Butterfly Valves with Actuator	T530
Absperrklappen mit Antrieb		Butterfly Valves with Actuator	T730
Regelventile		Regulating Valve, BW	T5R, T6R, T5F-R, T6F-R
Regel/Absperrventile		Regulating /Shut-Off Valves, BW	T5F-R/AV, T6F-R/AV
Regelventile FABA		Regulating Valves Bellows	T5F-R.FA, T6F-R.FA
Regelventile CO ²		Regulating Valves CO ² , BW	T5F-CO2-R, T6F-CO2-R
Expansionsventile		Expansion Valves	T150.EXP
Schmutzsammler		Strainer, BW	T5F-SS, T6F-SS
Rückschlagventile		Check Valve, BW	T5F-RUV, T6F-RUV
Absperr/Rückschlagventile		Stop/Check Valve, BW	T5F.RUV/AV, T6F.RUV/AV
Absperr/Rückschlagventile CO ²		Stop/Check Valve CO ² , BW	T5(6)F.RUV/AV-CO2
Rückschlagklappen		Swing Check Valves	R1S
Überströmventile, BW		Overflow Valves, BW	T6F-UV
Ventile mit Muffen-Schweißenden ANSI, Stahl		Valves with socket weld ends, Steel	Serie
Absperrventile, SW		Shut-Off Valves, SW	T51F, T61F
Absperrventile CO ² , SW		Shut-Off Valves CO ² , SW	T51F-CO2, T61F-CO2
Regelventile, SW		Regulating Valve, SW	T51F-R, T61F-R
Regelventile CO ² , SW		Regulating Valves CO ² , SW	T51F-CO2-R, T61-CO2-R
Schmutzsammler, SW		Strainer, SW	T51F-SS, T61F-SS
Rückschlagventile, SW		Check Valve, SW	T51F-RUV, T61F-RUV
Ventile mit FPT Gewinde, Stahl		Valves with FPT Thread, Steel	Serie
Absperrventile, SW/FPT		Shut-Off Valves, SW/FPT	T51(62)F.SW/FPT
Absperrventile CO ² , SW/FPT		Shut-Off Valves CO ² , SW/FPT	T51(61)F.SW/FPT-CO2
Regelventile, SW/FPT		Regulating Valve, SW/FPT	T51(62)F.SW/FPT-R
Regelventile CO ² , SW/FPT		Regulating Valves CO ² , SW/FPT	T51(61)F.SW/FPT-CO2-R
Absperrventile, FPT		Shut-Off Valves, FPT	T52F, T62F
Absperrventile CO ² , FPT		Shut-Off Valves CO ² , FPT	T52F.CO2, T61F.CO2
Regelventile, FPT		Regulating Valve, FPT	T52F-R, T62F-R
Regelventile CO ² , FPT		Regulating Valves CO ² , FPT	T52F-CO2-R, T62F-CO2-R
Schmutzsammler, FPT		Strainer, FPT	T52F-SS, T62F-SS
Rückschlagventile, FPT		Check Valve, FPT	T52F-RUV, T62F-RUV
Flanschventile, Stahl		Valves with Flanges, Steel	Serie
Absperrventile, Flansch		Shut-Off Valves, Flange	T2V, T11V
Absperrventile FABA, Flansch		Shut-Off Valves Bellows, Flange	T2V.FA, T11V.FA
Absperrventile Flansch, CO ²		Shut-Off Valves Flange, CO ²	T2V.-CO2, T11V-CO2
Regelventile, Flansch		Regulating Valves, Flange	T2V-R, T11V-R
Regelventile FABA, Flansch		Regulating Valves Bellows, Flange	T2V.FA-R, T11V.FA-R
Regelventile Flansch, CO ²		Regulating Valves Flange, CO ²	T2V-CO2-R, T11V-CO2-R
Schmutzsammler, Flansch		Strainer, Flange	T2V-SS, T11V-SS
Rückschlagventile, Flansch		Check Valve, Flange	T2V-RUV, T11V-RUV
Sicherheitsarmaturen, Stahl		Safety Valves, Steel	Serie
Sicherheitsventile BPD		Safety Valves BPD	T21, T21F, T23V
Sicherheitsventile BPI		Safety Valves BPI	T21.FA, T21F.FA, T23V.FA
3-Wege-Ventile		3-Way-Valves	T19A, T25V, T25V-CO2
Sicherheitsventil-Kombi. BPD		Dual Safety Valves BPD	T19, T19F, T24V
Sicherheitsventil-Kombinationen BPI		Dual Safety Valves BPI	T19.FA, T19F.FA, T24V.FA

see next page for further valves

Inhalt

Contents

Standard* Ventile, Edelstahl	Standard* Valves, Stainless Steel	Serie	Seite/Page
Serviceventile VA	Service Valves SS	T37VA, T34VA	48
Serviceventile VA	Service Valves SS	T37VA.S9.3.1	49
Serviceventile VA	Service Valves SS	T64VA, T63VA	50
Ölablassventil VA	Oil Drain Valve SS	T38VA.E	50
Absperrventile VA	Shut-Off Valves SS	T5(6)VA, T5VA.F, T6VA.F	51
Absperrventile VA, FABA	Shut-Off Valves SS, Bellows	T5VA.F.FA, T6VA.F.FA	52
Absperrventile CO ² Edelstahl	Shut-Off Valves CO ² Stainless Steel	T5(6)VA.F-CO2	53
Kugelventile Edelstahl	Ball Valves Stainless Steel	T42VA, T43VA	54
Kugelventile VA mit Antrieb	Ball Valves SS with Actuator	T420VA, T430VA	55
Kugelventile VA mit Antrieb	Ball Valves SS with Actuator	T620VA, T630VA	56
Absperrklappen VA	Butterfly Valves SS	T53VA	57
Absperrklappen VA mit Antrieb	Butterfly Valves SS with Actuator	T530VA	57
Absperrklappen VA mit Antrieb	Butterfly Valves SS with Actuator	T730VA	58
Regelventile Edelstahl	Regulating Valve Stainless Steel	T5(6)VA-R, T5(6)VA.F-R	59
Regel/Absperrventile VA	Regulating /Shut-Off Valves, SS	T5(6)VA.F-R/AV	60
Regelventile VA, FABA	Regulating Valves SS, Bellows	T5(6)VA.F.FA-R	61
Regelventile VA, CO ²	Regulating Valves SS, CO ²	T5(6)VA.F-CO2-R	62
Schmutzsammler VA	Strainer SS	T5VA.F-SS, T6VA.F-SS	63
Rückschlagventile VA	Check Valve SS	T5(6)VA.F-RUV	63
Absperr/Rückschlagv. VA	Stop/Check Valve SS	T5(6)VA.F.RUV/AV	64
Absperr/Rückschlagventile VA, CO ²	Stop/Check Valve SS CO ²	T5(6)VA.F.RUV/AV-CO2	65
Rückschlagklappen VA	Swing Check Valves SS	R1S.VA	66
Überströmventile VA	Overflow Valves SS	T6VA.F-UV	66
Sicherheitsarmaturen, Edelstahl	Safety Valves, Stainless Steel	Serie	Seite/Page
Sicherheitsventile VA BPD	Safety Valves SS BPD	T21VA, T23VA	67
Sicherheitsventile VA BPI	Safety Valves SS BPI	T21VA.FA, T23VA.FA	68
3-Wege-Ventile VA	3-Way-Valves SS	T25VA, T25VA-CO2	69
Sicherheitsventil-Kombi. VA BPD	Dual Safety Valves SS BPD	T24VA	69
Berstscheiben	Bursting Disc	KUB, UKB	70
Entspannungsventile	Excess Flow Valves	PV	70
Flüssigkeitsstandkontrolle	Liquid Level Controls	Serie	Seite/Page
Schaugläser	Sight Glasses	T111, SG1	71
NH3 Flüssigkeitsschalter	NH3 Liquid Switch	HBSR	71
CO2 Flüssigkeitsschalter	CO2 Liquid Level Switch	HBSC2	71
Öl Schalter	Oil Switch	HBS01	71
Niveausonde	Level Transmitter	HBLT wire	71
Zusätzliches	Additional	Seite/Page	
Abnahmen & Bescheinigungen	Tests & Certificates*	72	
Markierungen	TAG's	72	
	General Conditions of Sale - Parker Hannifin GmbH	73	
Allgemeine Verkaufsbedingungen der Parker Hannifin GmbH		76	

Kontakt Liste

Contact List

Vertrieb / Sales

Management

Francesco Galante Sales Manager Industrial Refrigeration EMEA Mobile: +44 (0) 1709 774600
E-Mail: francesco.galante@parker.com

Angebotserstellung & technische Fragen / Quotation & Technical Support

Werner Pomper Quotation Administrative Operator Phone: +49 (0) 2131 401 69 471
E-Mail: wpomper@parker.com

Frank Pilz Application Engineer Phone: +49 (0) 4152-876 890
Mobile: +49 (0) 151-16 77 81 92
E-Mail: fpilz@parker.com

Eduardo Seufferheld Sales Engineer (DACH) Mobile: +49 (0) 151-12 58 15 69
E-Mail: eduardo.seufferheld@parker.com

Sammeladresse / Hotline Email: herlsalesupport@parker.com

Aufträge, Reklamationen & Versand / Orders, Complaints & Shipments

Ditmar Stolzing Sales Administrative Operator Phone: +49 (0) 2131 401 69 473
E-Mail: dstolzing@parker.com

Sammeladresse / Hotline Email: herlcustomerservice@parker.com

ENGINEERING **YOUR** SUCCESS.

Bestellhinweis

How To Order

Hand Valves can be specified by using the symbols in the chart below to develop a model number. Select only those symbols that represent the features desired, and place them in the sequence indicated by the example at the top of the chart.

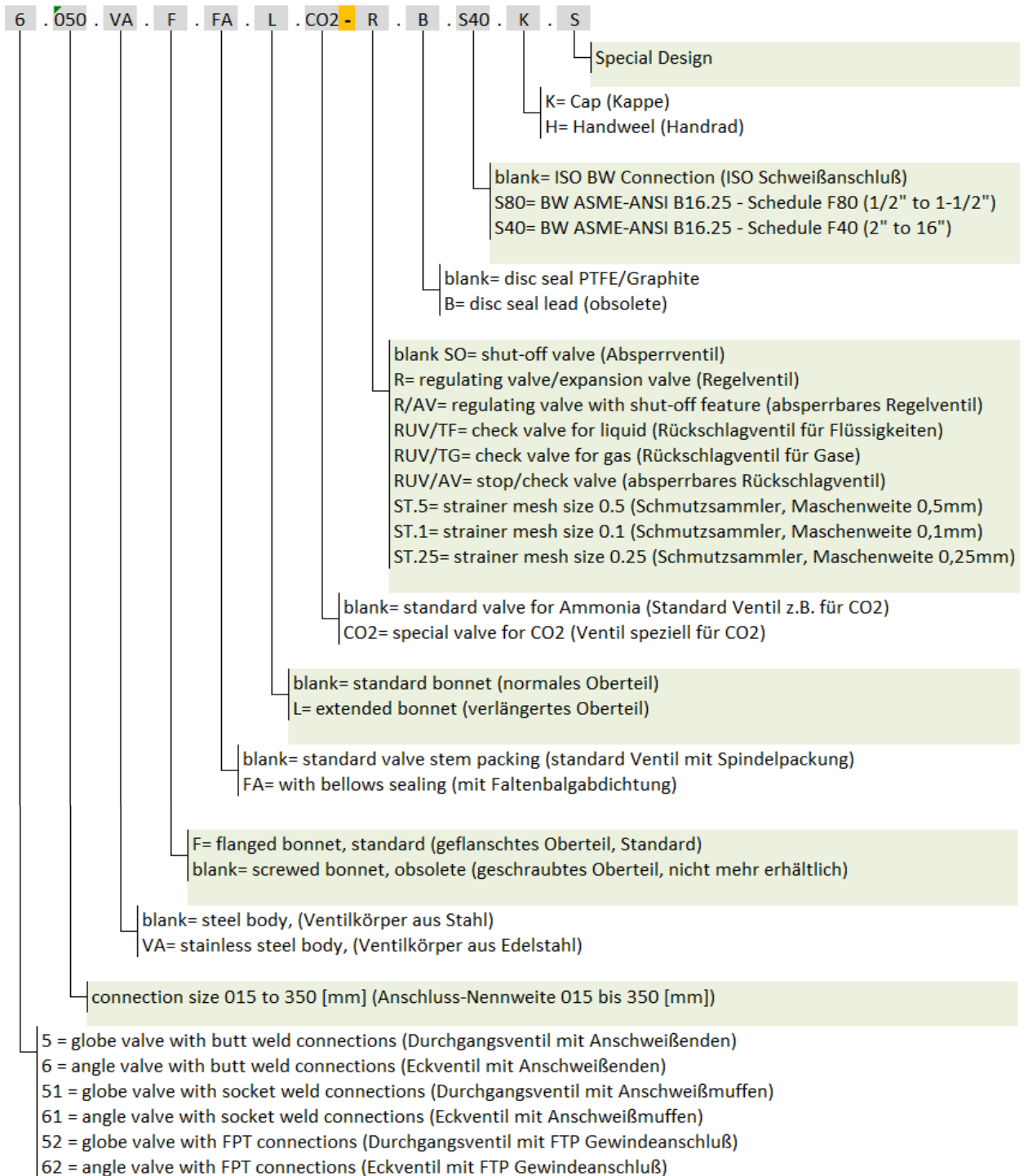

Wichtige Hinweise

Important Remarks

Wichtige Hinweise

Wir liefern die beschriebene Standard-Ausführung zum Listenpreis

für die Standard-Anwendung mit den gängigen Kältemittel NH3, R22, R134a, R404, R407, R507 von -50°C bis 120°C, PN25 entsprechend der Ausführung in unserem technischen Katalog.

Andere Kältemittel müssen mit den Betriebsbedingungen in der Bestellung spezifiziert werden!

Werden handbetätigte Ventile nicht ausdrücklich mit Handrad bestellt, liefern wir serienmäßig mit Kappe.

Ventile für CO2 müssen mit Betriebsbedingungen bestellt werden!

CO2-Ventile setzen den Einsatz von trockenem (nicht feuchtem) Kältemittel oder Kälteträger voraus. Für Absperr-, Regel- und Wechselventile für CO2 sind spezielle Preise angegeben.

Für Armaturen mit Stellantrieb, Rückschlagventile, Schmutzsammler und Sicherheitsventile für CO2 gelten die Standardpreise. Die Armaturen müssen jedoch mit Hinweis auf CO2 bestellt werden.

Ventile für feuchtes CO2 müssen ausdrücklich angefragt werden!

Ventile für Kühlsolen auf Glykol-Basis:

Die Sole muß mit den Betriebsbedingungen angegeben werden.

Es gelten die Preise für die Standard-Ausführung.

Die technische Ausführung ist/kann abweichend vom Standardventil sein. Deshalb keine Standard-Ausführung für Sole einsetzen!

Ventile für alle anderen Kältemittel und Kälteträger, bzw. für tiefere/höhere Temperaturen und Drücke

müssen unter Angabe der Betriebsdaten bestellt werden, zur Überprüfung der Eignung der Standard-Ausführung. Gegebenenfalls werden andere Werkstoffe, Dichtungen, Schmiermittel verwendet.

Abhängig von der erforderlichen Ausführung können Mehrpreise anfallen.

Ersatzteile für Sicherheitsventile werden ausschließlich nur an autorisierte Fachhändler verkauft.

Gewährleistungsansprüche für Sicherheitsventile werden nur bei unbeschädigter Original-Verplombung akzeptiert.

Spezielle Ausführungen bzw. Armaturen für besondere Anforderungen: Bitte anfragen!

Important Remarks

We deliver the described standard design at list prices

for standard application with common refrigerants NH3, R22, R134a, R404a, R407, R507 from -50°C to 120°C, PN25 acc. to the design description in our technical catalogue.

Other refrigerants must be specified by customer.

Manual operated valves will be supplied with seal-cap, if handwheels are not especially required.

Valves for CO2 have to be ordered with working conditions!

Application with dry (not wet) CO2 as refrigerant or secondary refrigerant.

For shut-off valves, regulating valves, 3-way valves for CO2 special prices are listed.

Valves for wet CO2 on request

Valves for secondary refrigerants on glycol basis (brines)

The brine and application have to be specified and requested.

Do not use standard designs / products for brine systems!

Valves for all different refrigerants and brines or for higher or lower temperature and pressures,

please advice all operating datas on your order. So, we can check the suitability of the standard valves.

If applicable, we use different material, gaskets or grease.

Depending on the required execution may incur additional charges.

Spare parts for safety valves will only be sold to authorized distributors.

Warranty claims for safety valves will only be accepted with original, virgin seal.

Special designs, valves on special requests.

Serviceventile Service Valves

Stahl, handbetätigt, mit Spindelkappe, alternativ mit Handrad
Steel, manual actuated, with cap stem, optional with handwheel

T34 	mit Schweiß-Tüllen with nut and tail	Absperrentil, Durchgang	Sitz	Anschluss		Gewicht	Preis
		Shut Off Valve, Globe	Seat	Connection		Weight	Price
		Artikel-Nr. / Article-No.	[mm]	[inch]	[mm]	[kg]	[EUR]
		34.006.K	6	G1/2"	13 x 3,5	0,8	127,00 €
		34.008.K	8	G3/4"	17 x 4,5	1,2	obsolet
		34.010.K	10	G3/4"	17 x 3,5	1,2	obsolet
		34.012.K	12	G1"	22 x 5,0	1,6	obsolet

T37 	mit Schweiß-Tüllen with nut and tail	Absperrentil, Eck	Sitz	Anschluss		Gewicht	Preis
		Shut Off Valve, Angle	Seat	Connection		Weight	Price
		Artikel-Nr. / Article-No.	[mm]	[inch]	[mm]	[kg]	[EUR]
		37.006.K	6	G1/2"	13 x 3,5	0,8	127,00 €
		37.008.K	8	G3/4"	17 x 4,5	0,8	obsolet
		37.010.K	10	G3/4"	17 x 3,5	0,8	obsolet
		37.012.K	12	G1"	22 x 5,0	0,8	obsolet

T34.S1 	Serviceventil, Durchgang	Anschluss		Gewicht	Preis
	Service Valve, Globe	Connection		Weight	Price
	Artikel-Nr. / Article-No.	Ein/in	Austritt / outlet	[kg]	[EUR]
Eintritt / inlet	34.006.S1.K	13,5mm	G1/2"+Tülle 13,5	0,7	120,00 €
	34.006.S1.0.K	17,5mm	G1/2"+Tülle 13,5	0,7	120,00 €
	34.006.S1.1.K	21,5mm	G1/2"+Tülle 13,5	0,7	120,00 €

T37.S1 	Serviceventil, Eck	Anschluss		Gewicht	Preis
	Service Valve, Angle	Connection		Weight	Price
	Artikel-Nr. / Article-No.	Ein/in	Austritt / outlet	[kg]	[EUR]
Eintritt / inlet	37.006.S1.K	13,5mm	G1/2"+Tülle 13,5	0,7	120,00 €
	37.006.S1.0.K	17,5mm	G1/2"+Tülle 13,5	0,7	120,00 €
	37.006.S1.1.K	21,5mm	G1/2"+Tülle 13,5	0,7	120,00 €

T34.S2 	Serviceventil, Durchgang	Anschluss		Gewicht	Preis
	Service Valve, Globe	Connection		Weight	Price
	Artikel-Nr. / Article-No.	Ein/in	Austritt / outlet	[kg]	[EUR]
Eintritt / inlet	34.006.S2.K	13,5mm	G1/2" Blindmutter/Blind Nut	0,7	120,00 €
	34.006.S2.0.K	17,5mm	G1/2" Blindmutter/Blind Nut	0,7	120,00 €
	34.006.S2.1.K	21,5mm	G1/2" Blindmutter/Blind Nut	0,7	120,00 €

T37.S2 	Serviceventil, Eck	Anschluss		Gewicht	Preis
	Service Valve, Angle	Connection		Weight	Price
	Artikel-Nr. / Article-No.	Ein/in	Austritt / outlet	[kg]	[EUR]
Eintritt / inlet	37.006.S2.K	13,5mm	G1/2" Blindmutter/Blind Nut	0,7	120,00 €
	37.006.S2.0.K	17,5mm	G1/2" Blindmutter/Blind Nut	0,7	120,00 €
	37.006.S2.1.K	21,5mm	G1/2" Blindmutter/Blind Nut	0,7	120,00 €

T34.S3 	Ermetoventil, Durchgang	Anschluss		Gewicht	Preis
	Ermeto Valve, Globe	Connection		Weight	Price
	Artikel-Nr. / Article-No.	Ein/in	Austritt / outlet	[kg]	[EUR]
Eintritt / inlet	34.006.S3.K	13,5mm	10mm Ermeto	0,7	169,00 €
S3...	34.006.S3.0.K	17,5mm	10mm Ermeto	0,7	169,00 €
S3.3	34.006.S3.1.K	21,5mm	10mm Ermeto	0,7	169,00 €
	34.006.S3.3.K	G1/2"+Tülle 13,5	10mm Ermeto	0,7	169,00 €

T37.S3 	Ermetoventil, Eck	Anschluss		Gewicht	Preis
	Ermeto Valve, Angle	Connection		Weight	Price
	Artikel-Nr. / Article-No.	Ein/in	Austritt / outlet	[kg]	[EUR]
Eintritt / inlet	37.006.S3.K	13,5mm	10mm Ermeto	0,7	169,00 €
S3...	37.006.S3.0.K	17,5mm	10mm Ermeto	0,7	169,00 €
S3.3	37.006.S3.1.K	21,5mm	10mm Ermeto	0,7	169,00 €
	37.006.S3.3.K	G1/2"+Tülle 13,5	10mm Ermeto	0,7	169,00 €

Serviceventile Service Valves

Stahl, handbetätigt, mit Spindelkappe, alternativ mit Handrad
Steel, manual actuated, with cap stem, optional with handwheel

	T34.S4	Serviceventil, Durchgang		Anschluss		Gewicht	Preis
		Service Valve, Globe		Connection		Weight	Price
		Artikel-Nr. / Article-No.	Ein/in	Austritt / outlet	[kg]	[EUR]	
Eintritt / inlet		Austritt / outlet	34.006.S4.K	G1/2"+Tülle 13,5 G1/2"+Tail 13,5	Blindmutter Blind Nut	0,7	120,00 €

	T37.S4	Serviceventil, Eck		Anschluss		Gewicht	Preis
		Service Valve, Angle		Connection		Weight	Price
		Artikel-Nr. / Article-No.	Ein/in	Austritt / outlet	[kg]	[EUR]	
Eintritt / inlet		Austritt / outlet	37.006.S4.K	G1/2"+Tülle 13,5 G1/2"+Tail 13,5	Blindmutter Blind Nut	0,7	120,00 €

	T34.S6	Manometerventil, Durchg.		Anschluss		Gewicht	Preis
		Gauge Valve, Globe		Connection		Weight	Price
		Artikel-Nr. / Article-No.	Ein/in	Austritt / outlet	[kg]	[EUR]	
Eintritt / inlet		Austritt / outlet	34.006.S6.K	13,5mm	G1/2" R/L	0,7	120,00 €
			34.006.S6.0.K	17,5mm	G1/2" R/L	0,7	120,00 €
			34.006.S6.1.K	21,5mm	G1/2" R/L	0,7	120,00 €
			34.006.S6.3.K	G1/2"+Tülle 13,5	G1/2" R/L	0,7	120,00 €

	T37.S6	Manometerventil, Eck		Anschluss		Gewicht	Preis
		Gauge Valve, Angle		Connection		Weight	Price
		Artikel-Nr. / Article-No.	Ein/in	Austritt / outlet	[kg]	[EUR]	
Eintritt / inlet		Austritt / outlet	37.006.S6.K	13,5mm	G1/2" R/L	0,7	120,00 €
			37.006.S6.0.K	17,5mm	G1/2" R/L	0,7	116,00 €
			37.006.S6.1.K	21,5mm	G1/2" R/L	0,7	120,00 €
			37.006.S6.3.K	G1/2"+Tülle 13,5	G1/2" R/L	0,7	120,00 €

	T64.S6.3	Manometerventil, Durchg.		Anschluss		Gewicht	Preis
		Gauge Valve, Globe		Connection		Weight	Price
		Artikel-Nr. / Article-No.	Ein/in	Austritt / outlet	[kg]	[EUR]	
Eintritt / inlet		Austritt / outlet	64.6.3.K	G1/2"+Tülle 13,5	G1/2" R/L	0,7	91,00 €

	T63.S6.3	Manometerventil, Eck		Anschluss		Gewicht	Preis
		Gauge Valve, Angle		Connection		Weight	Price
		Artikel-Nr. / Article-No.	Ein/in	Austritt / outlet	[kg]	[EUR]	
Eintritt / inlet		Austritt / outlet	63.6.3.K	G1/2"+Tülle 13,5	G1/2" R/L	0,7	91,00 €

Ölablassventil Oil Drain Valve

Stahl, handbetätigt
Steel, manual actuated

	T38V.E	Ölablassventil, Eck		Anschluss		Gewicht	Preis
		Oil Drain Valve, Angle		Connection		Weight	Price
		Artikel-Nr. / Article-No.	DN	Inch	[kg]	[EUR]	
		38.015.V.E	15	1/2"	2,3	258,00 €	

Absperrventile

Shut-Off Valves, BW

Standard: handbetätigt, aus Stahl, mit ISO Anschweißenden, Kappe, PN25

Standard: manual actuated, made of steel, with butt weld ends ISO, cap, PN25

Alternative: Anschweißenden mit Schweißfase nach ANSI, Schedule, mit Handrad

Alternative: butt weld ends according ANSI, Schedule, with handwheel

T5	Absperrventil, Durchgang Shut Off Valve, Globe	Anschluss		Kvs	Gewicht	Preis	
		Connection		Kvs	Weight	Price	
		Artikel-Nr. / Article-No.	DN	Inch	[m³/h]	[kg]	[EUR]
	Oberteil geschraubt Screwed bonnet	5.006.K	6	1/4"	0,73	0,6	110,00 €
		5.008.K	8	5/16"	1,35	0,9	obsolete
		5.012.K	12	1/2"	2,13	0,9	obsolete

T6	Absperrventil, Eck Shut Off Valve, Angle	Connection		Kvs	Weight	Price	
		Connection		Kvs	Weight	Price	
		Artikel-Nr. / Article-No.	DN	Inch	[m³/h]	[kg]	[EUR]
	Oberteil geschraubt Screwed bonnet	6.006.K	6	1/4"	1,06	0,5	110,00 €
		6.008.K	8	5/16"	1,80	0,8	obsolete
		6.012.K	12	1/2"	4,04	0,8	obsolete

T5F	Absperrventil, Durchgang Shut Off Valve, Globe	Anschluss		Kvs	Gewicht	Preis	
		Connection		Kvs	Weight	Price	
		Artikel-Nr. / Article-No.	DN	Inch	[m³/h]	[kg]	[EUR]
	Oberteil geflanscht Bolted bonnet	5.015.F.K	15	1/2"	3,1	1,4	136,00 €
		5.020.F.K	20	3/4"	6,1	1,6	141,00 €
		5.025.F.K	25	1"	10,0	2,9	167,00 €
		5.032.F.K	32	1-1/4"	15,0	3,5	193,00 €
		5.040.F.K	40	1-1/2"	23,3	4,3	228,00 €
		5.050.F.K	50	2"	38,1	6,3	290,00 €
	Oberteil geflanscht Bolted bonnet	5.065.F.K	65	2-1/2"	69,6	19,1	420,00 €
		5.080.F.K	80	3"	100	21,2	517,00 €
		5.100.F.K	100	4"	159	30,0	642,00 €
		5.125.F.K	125	5"	242	50,0	1.007,00 €
		5.150.F.K	150	6"	406	82,0	1.453,00 €
		5.200.F.K	200	8"	628	139,0	2.446,00 €
		5.250.F.K	250	10"	855	271,0	6.164,00 €
		5.300.F.K	300	12"	1.287	347,0	7.664,00 €
		5.350.F.K	350	14"	2.280	625,0	15.633,00 €
		5.400.F.K	400	16"	2.490	800,0	obsolete
	mit Vorhubkegel with equalibrating disc	5.250.F.HUB.K	250	10"	855	271,0	6.760,00 €
		5.300.F.HUB.K	300	12"	1.287	347,0	8.275,00 €
		5.350.F.HUB.K	350	14"	2.280	625,0	16.454,00 €
		5.400.F.HUB.K	400	16"	2.490	800,0	obsolete

T6F	Absperrventil, Eck Shut Off Valve, Angle	Anschluss		Kvs	Gewicht	Preis	
		Connection		Kvs	Weight	Price	
		Artikel-Nr. / Article-No.	DN	Inch	[m³/h]	[kg]	[EUR]
	Oberteil geflanscht Bolted bonnet	6.015.F.K	15	1/2"	3,6	1,3	132,00 €
		6.020.F.K	20	3/4"	8,0	1,4	138,00 €
		6.025.F.K	25	1"	15,6	2,7	159,00 €
		6.032.F.K	32	1-1/4"	28,4	2,9	183,00 €
		6.040.F.K	40	1-1/2"	28,5	3,8	219,00 €
		6.050.F.K	50	2"	53,7	4,9	244,00 €
		6.065.F.K	65	2-1/2"	84	13,5	387,00 €
		6.080.F.K	80	3"	149	14,7	487,00 €
		6.100.F.K	100	4"	218	20,6	561,00 €
		6.125.F.K	125	5"	418	36,0	865,00 €
		6.150.F.K	150	6"	607	55,0	1.169,00 €
		6.200.F.K	200	8"	942	82,0	2.251,00 €
		6.250.F.K	250	10"	1.435	242,0	5.395,00 €
		6.300.F.K	300	12"	1.657	299,0	6.266,00 €
		6.350.F.K	350	14"	2.535	525,0	12.333,00 €
		6.400.F.K	400	16"	3.206	561,0	obsolete
	mit Vorhubkegel with equalibrating disc	6.250.F.HUB.K	250	10"	1.435	242,0	5.993,00 €
		6.300.F.HUB.K	300	12"	1.657	299,0	6.875,00 €
		6.350.F.HUB.K	350	14"	2.535	525,0	13.154,00 €
		6.400.F.HUB.K	400	16"	3.206	561,0	obsolete

Absperrventile Shut-Off Valves, BW

Standard: handbetätigt, aus Stahl, mit ISO Anschweißenden, Kappe, PN25
Standard: manual actuated, made of steel, with butt weld ends ISO, cap, PN25
Alternative: Anschweißenden mit Schweißfase nach ANSI, Schedule, mit Handrad
Alternative: butt weld ends according ANSI, Schedule, with handwheel

T5F.L		Absperrventil, Durchgang	Anschluss		Kvs	Gewicht	Preis
		Shut Off Valve, Globe	Connection		Kvs	Weight	Price
		Artikel-Nr. / Article-No.	DN	Inch	[m³/h]	[kg]	[EUR]
	Verlängertes Oberteil Extended bonnet	5.015.F.L.K	15	1/2"	3,1	1,8	151,00 €
		5.020.F.L.K	20	3/4"	6,1	1,9	156,00 €
		5.025.F.L.K	25	1"	10,0	3,4	193,00 €
		5.032.F.L.K	32	1-1/4"	15,0	3,7	223,00 €
		5.040.F.L.K	40	1-1/2"	23,3	5,2	247,00 €
		5.050.F.L.K	50	2"	38,1	6,4	308,00 €
		5.065.F.L.K	65	2-1/2"	69,6	22,0	499,00 €
		5.080.F.L.K	80	3"	100	27,0	593,00 €
		5.100.F.L.K	100	4"	159	32,0	719,00 €
		5.125.F.L.K	125	5"	242	56,0	1.294,00 €
		5.150.F.L.K	150	6"	406	93,0	1.734,00 €
		5.200.F.L.K	200	8"	628	145,0	2.807,00 €

T6F.L		Absperrventil, Eck	Connection		Kvs	Weight	Price
		Shut Off Valve, Angle	Connection		Kvs	Weight	Price
		Artikel-Nr. / Article-No.	DN	Inch	[m³/h]	[kg]	[EUR]
	Verlängertes Oberteil Extended bonnet	6.015.F.L.K	15	1/2"	3,6	1,5	146,00 €
		6.020.F.L.K	20	3/4"	8,0	1,7	153,00 €
		6.025.F.L.K	25	1"	15,6	3,0	185,00 €
		6.032.F.L.K	32	1-1/4"	28,4	3,5	213,00 €
		6.040.F.L.K	40	1-1/2"	28,5	4,1	235,00 €
		6.050.F.L.K	50	2"	53,7	5,4	262,00 €
		6.065.F.L.K	65	2-1/2"	84	16,7	466,00 €
		6.080.F.L.K	80	3"	149	20,2	566,00 €
		6.100.F.L.K	100	4"	218	24,0	641,00 €
		6.125.F.L.K	125	5"	418	43,0	1.150,00 €
		6.150.F.L.K	150	6"	607	65,0	1.453,00 €
		6.200.F.L.K	200	8"	942	94,0	2.613,00 €

Absperrventile FABA Shut-Off Valves Bellows

Standard: handbetätigt, aus Stahl, mit ISO Anschweißenden, Kappe, PN25
Standard: manual actuated, made of steel, with butt weld ends ISO, cap, PN25
Alternative: Anschweißenden mit Schweißfase nach ANSI, Schedule, mit Handrad
Alternative: butt weld ends according ANSI, Schedule, with handwheel

T5F.FA		Absperrventil, Durchgang	Anschluss		Kvs	Gewicht	Preis
		Shut Off Valve, Globe	Connection		Kvs	Weight	Price
		Artikel-Nr. / Article-No.	DN	Inch	[m³/h]	[kg]	[EUR]
	Spindelabdichtung: Faltenbalg Oberteil geflanscht Stem Sealing: Bellows Seal Bolted bonnet	5.015.F.FA.K	15	1/2"	3,1	1,8	402,00 €
		5.020.F.FA.K	20	3/4"	6,1	2,0	418,00 €
		5.025.F.FA.K	25	1"	10,0	3,5	485,00 €
		5.032.F.FA.K	32	1-1/4"	15,0	4,0	557,00 €
		5.040.F.FA.K	40	1-1/2"	23,3	5,5	673,00 €
		5.050.F.FA.K	50	2"	38,1	7,2	755,00 €
		5.065.F.FA.K	65	2-1/2"	69,6	24,0	1.374,00 €
		5.080.F.FA.K	80	3"	100	26,5	1.509,00 €
		5.100.F.FA.K	100	4"	159	33,0	1.740,00 €
		5.125.F.FA.K	125	5"	242	63,0	3.947,00 €
		5.150.F.FA.K	150	6"	406	99,0	5.112,00 €
		5.200.F.FA.K	200	8"	628	180,0	7.757,00 €

T6F.FA		Absperrventil, Eck	Anschluss		Kvs	Gewicht	Preis
		Shut Off Valve, Angle	Connection		Kvs	Weight	Price
		Artikel-Nr. / Article-No.	DN	Inch	[m³/h]	[kg]	[EUR]
	Spindelabdichtung: Faltenbalg Oberteil geflanscht Stem Sealing: Bellows Seal Bolted bonnet	6.015.F.FA.K	15	1/2"	3,6	1,6	399,00 €
		6.020.F.FA.K	20	3/4"	8,0	1,7	417,00 €
		6.025.F.FA.K	25	1"	15,6	3,2	480,00 €
		6.032.F.FA.K	32	1-1/4"	28,4	3,7	547,00 €
		6.040.F.FA.K	40	1-1/2"	28,5	4,7	661,00 €
		6.050.F.FA.K	50	2"	53,7	5,9	708,00 €
		6.065.F.FA.K	65	2-1/2"	84	18,9	1.342,00 €
		6.080.F.FA.K	80	3"	149	20,3	1.481,00 €
		6.100.F.FA.K	100	4"	218	24,4	1.661,00 €
		6.125.F.FA.K	125	5"	418	49,0	3.805,00 €
		6.150.F.FA.K	150	6"	607	73,0	4.832,00 €
		6.200.F.FA.K	200	8"	942	115,0	7.559,00 €

Absperrventile CO²

Shut-Off Valves CO², BW

Standard: handbetätigt, aus Stahl, mit ISO Anschweißenden, Kappe, PN40

Standard: manual actuated, made of steel, with butt weld ends ISO, cap, PN40

Alternative: Anschweißenden mit Schweißfase nach ANSI, Schedule, mit Handrad

Alternative: butt weld ends according ANSI, Schedule, with handwheel

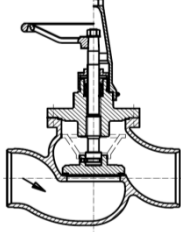
T5F-CO2		absperrentil, Durchgang	Anschluss		Kvs	Gewicht	Preis
		Shut Off Valve, Globe	Connection		Kvs	Weight	Price
 Oberteil geflanscht Für trockenes CO2 Bolted bonnet For dry CO2		Artikel-Nr. / Article-No.	DN	Inch	[m³/h]	[kg]	[EUR]
		5.015.F-CO2.K	15	1/2"	3,1	1,4	148,00 €
5.020.F-CO2.K	20	3/4"	6,1	1,6	154,00 €		
5.025.F-CO2.K	25	1"	10,0	2,9	187,00 €		
5.032.F-CO2.K	32	1-1/4"	15,0	3,5	218,00 €		
5.040.F-CO2.K	40	1-1/2"	23,3	4,3	257,00 €		
5.050.F-CO2.K	50	2"	38,1	6,3	323,00 €		
5.065.F-CO2.K	65	2-1/2"	69,6	19,1	485,00 €		
5.080.F-CO2.K	80	3"	100	21,2	581,00 €		
5.100.F-CO2.K	100	4"	159	30,0	714,00 €		
5.125.F-CO2.K	125	5"	242	50,0	1.119,00 €		
5.150.F-CO2.K	150	6"	406	82,0	1.615,00 €		
5.200.F-CO2.K	200	8"	628	139,0	2.668,00 €		

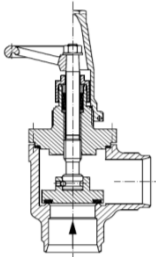
T6F-CO2		Absperrventil, Eck	Anschluss		Kvs	Gewicht	Preis
		Shut Off Valve, Angle	Connection		Kvs	Weight	Price
 Oberteil geflanscht Für trockenes CO2 Bolted bonnet For dry CO2		Artikel-Nr. / Article-No.	DN	Inch	[m³/h]	[kg]	[EUR]
		6.015.F-CO2.K	15	1/2"	3,6	1,3	144,00 €
6.020.F-CO2.K	20	3/4"	8,0	1,4	152,00 €		
6.025.F-CO2.K	25	1"	15,6	2,7	179,00 €		
6.032.F-CO2.K	32	1-1/4"	28,4	2,9	206,00 €		
6.040.F-CO2.K	40	1-1/2"	28,5	3,8	246,00 €		
6.050.F-CO2.K	50	2"	53,7	4,9	274,00 €		
6.065.F-CO2.K	65	2-1/2"	84	13,5	447,00 €		
6.080.F-CO2.K	80	3"	149	14,7	551,00 €		
6.100.F-CO2.K	100	4"	218	20,6	631,00 €		
6.125.F-CO2.K	125	5"	418	36,0	968,00 €		
6.150.F-CO2.K	150	6"	607	55,0	1.317,00 €		
6.200.F-CO2.K	200	8"	942	82,0	2.459,00 €		

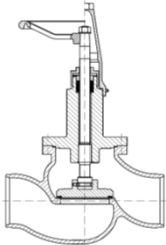
T5F.L-CO2		absperrentil, Durchgang	Anschluss		Kvs	Gewicht	Preis
		Shut Off Valve, Globe	Connection		Kvs	Weight	Price
 Oberteil geflanscht Für trockenes CO2 Verlängertes Oberteil Bolted bonnet For dry CO2 Extended bonnet		Artikel-Nr. / Article-No.	DN	Inch	[m³/h]	[kg]	[EUR]
		5.015.F.L-CO2.K	15	1/2"	3,1	1,8	173,00 €
5.020.F.L-CO2.K	20	3/4"	6,1	1,9	178,00 €		
5.025.F.L-CO2.K	25	1"	10,0	3,4	223,00 €		
5.032.F.L-CO2.K	32	1-1/4"	15,0	3,7	254,00 €		
5.040.F.L-CO2.K	40	1-1/2"	23,3	5,2	289,00 €		
5.050.F.L-CO2.K	50	2"	38,1	6,4	355,00 €		
5.065.F.L-CO2.K	65	2-1/2"	69,6	22,0	577,00 €		
5.080.F.L-CO2.K	80	3"	100	27,0	674,00 €		
5.100.F.L-CO2.K	100	4"	159	32,0	808,00 €		
5.125.F.L-CO2.K	125	5"	242	56,0	1.452,00 €		
5.150.F.L-CO2.K	150	6"	406	93,0	1.943,00 €		
5.200.F.L-CO2.K	200	8"	628	145,0	3.077,00 €		

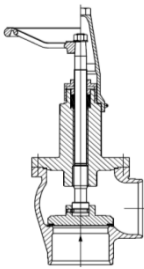
T6F.L-CO2		Absperrventil, Eck	Anschluss		Kvs	Gewicht	Preis
		Shut Off Valve, Angle	Connection		Kvs	Weight	Price
 Oberteil geflanscht Für trockenes CO2 Verlängertes Oberteil Bolted bonnet For dry CO2 Extended bonnet		Artikel-Nr. / Article-No.	DN	Inch	[m³/h]	[kg]	[EUR]
		6.015.F.L-CO2.K	15	1/2"	3,6	1,5	167,00 €
6.020.F.L-CO2.K	20	3/4"	8,0	1,7	176,00 €		
6.025.F.L-CO2.K	25	1"	15,6	3,0	216,00 €		
6.032.F.L-CO2.K	32	1-1/4"	28,4	3,5	242,00 €		
6.040.F.L-CO2.K	40	1-1/2"	28,5	4,1	278,00 €		
6.050.F.L-CO2.K	50	2"	53,7	5,4	306,00 €		
6.065.F.L-CO2.K	65	2-1/2"	84	16,7	542,00 €		
6.080.F.L-CO2.K	80	3"	149	20,2	647,00 €		
6.100.F.L-CO2.K	100	4"	218	24,0	723,00 €		
6.125.F.L-CO2.K	125	5"	418	43,0	1.301,00 €		
6.150.F.L-CO2.K	150	6"	607	65,0	1.647,00 €		
6.200.F.L-CO2.K	200	8"	942	94,0	2.872,00 €		

Kugelventile

Ball Valves

handbetätigt, aus Stahl, PN40, mit Handhebel, auch für CO2 geeignet
manual actuated, made of steel, PN40, with lever, also suitable for CO2

T42		Standard Mit Anschweißen Standard With butt weld ends ISO	Kugelventil	Sitz	Anschluss		Kvs	Gewicht	Preis
			Ball Valve	Seat	Connection		Kvs	Weight	Price
			Artikel-Nr. / Article-No.	[mm]	DN	Inch	[m³/h]	[kg]	[EUR]
42.015	11,1	15	1/2"	8	0,6	252,00 €			
42.020	14,2	20	3/4"	13	0,9	271,00 €			
42.025	20,6	25	1"	30	1,3	314,00 €			
42.032	25,4	32	1-1/4"	48	1,9	340,00 €			
42.040	31,7	40	1-1/2"	80	2,9	419,00 €			
42.050	38,0	50	2"	120	4,0	485,00 €			
42.065	50,0	65	2-1/2"	250	6,7	797,00 €			
42.080	62,0	80	3"	470	13,0	1.377,00 €			
42.100	82,4	100	4"	700	23,0	1.853,00 €			
42.125	100,0	125	5"	1250	37,0	2.911,00 €			
42.150	100,0	150	6"	1250	40,0	3.046,00 €			

T42L		Mit Isolierverlängerung Mit Anschweißen With Bonnet Extension With butt weld ends ISO	Kugelventil	Sitz	Anschluss		Kvs	Gewicht	Preis
			Ball Valve	Seat	Connection		Kvs	Weight	Price
			Artikel-Nr. / Article-No.	[mm]	DN	Inch	[m³/h]	[kg]	[EUR]
42.015.L	11,1	15	1/2"	8	1,6	506,00 €			
42.020.L	14,2	20	3/4"	13	1,9	527,00 €			
42.025.L	20,6	25	1"	30	2,5	621,00 €			
42.032.L	25,4	32	1-1/4"	48	3,1	647,00 €			
42.040.L	31,7	40	1-1/2"	80	4,6	782,00 €			
42.050.L	38,0	50	2"	120	5,7	848,00 €			
42.065.L	50,0	65	2-1/2"	250	9,8	1.423,00 €			
42.080.L	62,0	80	3"	470	16,0	2.140,00 €			
42.100.L	82,4	100	4"	700	29,0	2.821,00 €			
42.125.L	100,0	125	5"	1250	43,0	3.878,00 €			
42.150.L	100,0	150	6"	1250	46,0	4.015,00 €			

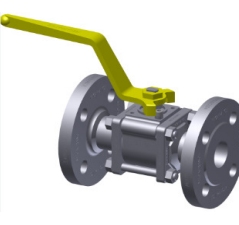
T43		Flanschschluß DIN2634 mit Nut EN1092-1 "D" With Flanged Connection DIN2634 with groove EN1092-1 "D"	Kugelventil	Sitz	Anschluss		Kvs	Gewicht	Preis
			Ball Valve	Seat	Connection		Kvs	Weight	Price
			Artikel-Nr. / Article-No.	[mm]	DN	Inch	[m³/h]	[kg]	[EUR]
43.015	11,1	15	1/2"	8	2,2	418,00 €			
43.020	14,2	20	3/4"	13	3,1	445,00 €			
43.025	20,6	25	1"	30	3,9	543,00 €			
43.032	25,4	32	1-1/4"	48	6,1	620,00 €			
43.040	31,7	40	1-1/2"	80	7,4	721,00 €			
43.050	38,0	50	2"	120	10,0	830,00 €			
43.065	50,0	65	2-1/2"	250	16,0	1.155,00 €			
43.080	62,0	80	3"	470	26,0	1.719,00 €			
43.100	82,4	100	4"	700	34,0	2.425,00 €			
43.125	100,0	125	5"	1250	47,0	3.232,00 €			
43.150	100,0	150	6"	1250	56,0	3.941,00 €			

T43L		mit Isolierverlängerung Flanschschluß DIN2634 mit Nut EN1092-1 "D" with extended bonnet With Flanged Connection DIN2634 with groove EN1092-1 "D"	Kugelventil	Sitz	Anschluss		Kvs	Gewicht	Preis
			Ball Valve	Seat	Connection		Kvs	Weight	Price
			Artikel-Nr. / Article-No.	[mm]	DN	Inch	[m³/h]	[kg]	[EUR]
43.015.L	11,1	15	1/2"	8	3,2	672,00 €			
43.020.L	14,2	20	3/4"	13	4,1	700,00 €			
43.025.L	20,6	25	1"	30	5,1	849,00 €			
43.032.L	25,4	32	1-1/4"	48	7,3	925,00 €			
43.040.L	31,7	40	1-1/2"	80	9,1	1.085,00 €			
43.050.L	38,0	50	2"	120	12,0	1.191,00 €			
43.065.L	50,0	65	2-1/2"	250	20,0	1.783,00 €			
43.080.L	62,0	80	3"	470	29,0	2.479,00 €			
43.100.L	82,4	100	4"	700	40,0	3.394,00 €			
43.125.L	100,0	125	5"	1250	53,0	4.200,00 €			
43.150.L	100,0	150	6"	1250	62,0	4.909,00 €			

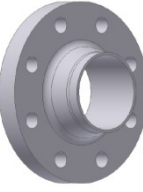
Gegenflansche / Counterflanges		Stahl, PN25/40 Schweißenden DIN2634 mit Feder EN1092-1 "C" mit Schrauben, Muttern und Dichtungen Steel, PN25/40 ISO Butt Weld Ends DIN2634 with tongue EN1092-1 "C" with bolts, nuts and gasket	Flansche (2 werden benötigt)		Anschluss		Gewicht	Preis
			Flange (you need 2 pcs.)		Connection		Weight	Price
			Artikel-Nr. / Article-No.		DN	Inch	[kg]	[EUR]
FLADINF.015.SMD		15	1/2"	1,8	40,00 €			
FLADINF.020.SMD		20	3/4"	2,5	42,00 €			
FLADINF.025.SMD		25	1"	2,9	43,00 €			
FLADINF.032.SMD		32	1-1/4"	4,1	61,00 €			
FLADINF.040.SMD		40	1-1/2"	4,8	67,00 €			
FLADINF.050.SMD		50	2"	6,1	74,00 €			
FLADINF.065.SMD		65	2-1/2"	9,0	101,00 €			
FLADINF.080.SMD		80	3"	11,0	111,00 €			
FLADINF.100.SMD		100	4"	16,5	167,00 €			
FLADINF.125.SMD		125	5"	23,0	295,00 €			
FLADINF.150.SMD		150	6"	28,5	324,00 €			

Kugelventile mit Antrieb

Ball Valves with Actuator

mit pneumatischer Antrieb, 3/2-Wege-Luftmagnetventil, 230V/50Hz, Endlagenschalter, aus Stahl, PN40
with pneumatic actuator, 3/2-way-solenoid-valve, 230V/50Hz, limit switches, made of steel, PN40

T420		Kugelventil	Sitz	Anschluss		Kvs	Gewicht	Preis
		Ball Valve	Seat	Connection		Kvs	Weight	Price
		Artikel-Nr. / Article-No.	[mm]	DN	Inch	[m³/h]	[kg]	[EUR]
Standard Mit Anschweißenden Standard With butt weld ends ISO	420.015	11,1	15	1/2"	8	4,8	1.550,00 €	
	420.020	14,2	20	3/4"	13	5,0	1.574,00 €	
	420.025	20,6	25	1"	30	6,6	1.803,00 €	
	420.032	25,4	32	1-1/4"	48	7,9	1.955,00 €	
	420.040	31,7	40	1-1/2"	80	11,0	2.089,00 €	
	420.050	38,0	50	2"	120	20,0	2.278,00 €	
	420.065	50,0	65	2-1/2"	250	21,0	3.187,00 €	
	420.080	62,0	80	3"	470	39,0	4.247,00 €	
	420.100	82,4	100	4"	700	67,0	5.334,00 €	
	420.125	100,0	125	5"	1250	99,0	7.019,00 €	
420.150	100,0	150	6"	1250	105,0	7.160,00 €		

T420H		Kugelventil	Sitz	Anschluss		Kvs	Gewicht	Preis
		Ball Valve	Seat	Connection		Kvs	Weight	Price
		Artikel-Nr. / Article-No.	[mm]	DN	Inch	[m³/h]	[kg]	[EUR]
Mit Handnotbetätigung Mit Anschweißenden with manual override With butt weld ends ISO	420.015.H	11,1	15	1/2"	8	6,3	2.669,00 €	
	420.020.H	14,2	20	3/4"	13	6,5	2.696,00 €	
	420.025.H	20,6	25	1"	30	8,3	2.924,00 €	
	420.032.H	25,4	32	1-1/4"	48	9,4	3.076,00 €	
	420.040.H	31,7	40	1-1/2"	80	16,0	3.209,00 €	
	420.050.H	38,0	50	2"	120	24,0	3.399,00 €	
	420.065.H	50,0	65	2-1/2"	250	25,0	4.307,00 €	
	420.080.H	62,0	80	3"	470	49,0	5.615,00 €	
	420.100.H	82,4	100	4"	700	77,0	6.701,00 €	
	420.125.H	100,0	125	5"	1250	109,0	8.388,00 €	
420.150.H	100,0	150	6"	1250	116,0	8.529,00 €		

T430		Kugelventil	Sitz	Anschluss		Kvs	Gewicht	Preis
		Ball Valve	Seat	Connection		Kvs	Weight	Price
		Artikel-Nr. / Article-No.	[mm]	DN	Inch	[m³/h]	[kg]	[EUR]
Flanschanschluß DIN2634 mit Nut EN1092-1 "D" With Flanged Connection DIN2634 with groove EN1092-1 "D"	430.015	11,1	15	1/2"	8	6,3	1.720,00 €	
	430.020	14,2	20	3/4"	13	7,0	1.749,00 €	
	430.025	20,6	25	1"	30	9,5	2.034,00 €	
	430.032	25,4	32	1-1/4"	48	11,6	2.230,00 €	
	430.040	31,7	40	1-1/2"	80	15,0	2.388,00 €	
	430.050	38,0	50	2"	120	26,0	2.622,00 €	
	430.065	50,0	65	2-1/2"	250	30,0	3.543,00 €	
	430.080	62,0	80	3"	470	51,0	4.588,00 €	
	430.100	82,4	100	4"	700	80,0	5.905,00 €	
	430.125	100,0	125	5"	1250	114,0	7.342,00 €	
430.150	100,0	150	6"	1250	130,0	8.056,00 €		

T430H		Kugelventil	Sitz	Anschluss		Kvs	Gewicht	Preis
		Ball Valve	Seat	Connection		Kvs	Weight	Price
		Artikel-Nr. / Article-No.	[mm]	DN	Inch	[m³/h]	[kg]	[EUR]
Mit Handnotbetätigung Flanschanschluß DIN2634 mit Nut EN1092-1 "D" With manual override With Flanged Connection DIN2634 with groove EN1092-1 "D"	430.015.H	11,1	15	1/2"	8	7,9	2.840,00 €	
	430.020.H	14,2	20	3/4"	13	8,5	2.870,00 €	
	430.025.H	20,6	25	1"	30	10,9	3.154,00 €	
	430.032.H	25,4	32	1-1/4"	48	13,1	3.351,00 €	
	430.040.H	31,7	40	1-1/2"	80	20,0	3.508,00 €	
	430.050.H	38,0	50	2"	120	31,0	3.742,00 €	
	430.065.H	50,0	65	2-1/2"	250	34,0	4.662,00 €	
	430.080.H	62,0	80	3"	470	51,0	5.956,00 €	
	430.100.H	82,4	100	4"	700	90,0	7.271,00 €	
	430.125.H	100,0	125	5"	1250	124,0	8.708,00 €	
430.150.H	100,0	150	8"	1250	140,0	9.424,00 €		

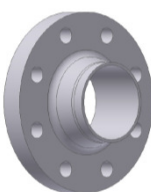
Gegenflansche / Counterflanges		Flansche (2 werden benötigt)	Anschluss		Gewicht	Preis
		Flange (you need 2 pcs.)	Connection		Weight	Price
		Artikel-Nr. / Article-No.	DN	Inch	[kg]	[EUR]
 Stahl, PN25/40 Schweißenden DIN2634 mit Feder EN1092-1 "C" mit Schrauben, Muttern und Dichtungen Steel, PN25/40 ISO Butt Weld Ends DIN2634 with tongue EN1092-1 "C" with bolts, nuts and gasket	FLADINF.015.SMD	15	1/2"	1,8	40,00 €	
	FLADINF.020.SMD	20	3/4"	2,5	42,00 €	
	FLADINF.025.SMD	25	1"	2,9	43,00 €	
	FLADINF.032.SMD	32	1-1/4"	4,1	61,00 €	
	FLADINF.040.SMD	40	1-1/2"	4,8	67,00 €	
	FLADINF.050.SMD	50	2"	6,1	74,00 €	
	FLADINF.065.SMD	65	2-1/2"	9,0	101,00 €	
	FLADINF.080.SMD	80	3"	11,0	111,00 €	
	FLADINF.100.SMD	100	4"	16,5	167,00 €	
	FLADINF.125.SMD	125	5"	23,0	295,00 €	
FLADINF.150.SMD	150	6"	28,5	324,00 €		

Kugelventile mit Antrieb

Ball Valves with Actuator

mit elektrischen Antrieb, 230V/50Hz, Endlagenschalter, aus Stahl, PN40
with electric actuator, 230V/50Hz, limit switches, made of steel, PN40

T620H		Kugelventil	Sitz	Anschluss		Kvs	Gewicht	Preis
		Ball Valve	Seat	Connection		Kvs	Weight	Price
		Artikel-Nr. / Article-No.	[mm]	DN	Inch	[m³/h]	[kg]	[EUR]
Mit Handnotbetätigung Mit Anschweißenden with manual override With butt weld ends ISO	620.015.H	11,1	15	1/2"	8	9,0	2.242,00 €	
	620.020.H	14,2	20	3/4"	13	10,0	2.268,00 €	
	620.025.H	20,6	25	1"	30	11,0	2.359,00 €	
	620.032.H	25,4	32	1-1/4"	48	12,0	2.385,00 €	
	620.040.H	31,7	40	1-1/2"	80	12,0	2.849,00 €	
	620.050.H	38,0	50	2"	120	13,0	2.911,00 €	
	620.065.H	50,0	65	2-1/2"	250	17,0	3.695,00 €	
	620.080.H	62,0	80	3"	470	33,0	4.959,00 €	
	620.100.H	82,4	100	4"	700	45,0	5.976,00 €	
	620.125.H	100,0	125	5"	1250	58,0	7.361,00 €	
	620.150.H	100,0	150	6"	1250	64,0	7.499,00 €	

T630H		Kugelventil	Sitz	Connection		Kvs	Weight	Price
		Ball Valve	Seat	Connection		Kvs	Weight	Price
		Article-No.	[mm]	DN	Inch	[m³/h]	[kg]	[EUR]
Handnotbetätigung Flanschschluß DIN2634 mit Nut EN1092-1 "D" Manual override With Flanged Connection DIN2634 with groove EN1092-1 "D"	630.015.H	11,1	15	1/2"	8	11,0	2.454,00 €	
	630.020.H	14,2	20	3/4"	13	12,0	2.487,00 €	
	630.025.H	20,6	25	1"	30	15,0	2.635,00 €	
	630.032.H	25,4	32	1-1/4"	48	16,0	2.710,00 €	
	630.040.H	31,7	40	1-1/2"	80	16,0	3.205,00 €	
	630.050.H	38,0	50	2"	120	19,0	3.310,00 €	
	630.065.H	50,0	65	2-1/2"	250	26,0	4.124,00 €	
	630.080.H	62,0	80	3"	470	44,0	5.395,00 €	
	630.100.H	82,4	100	4"	700	58,0	6.664,00 €	
	630.125.H	100,0	125	5"	1250	73,0	7.826,00 €	
	630.150.H	100,0	150	6"	1250	89,0	8.540,00 €	

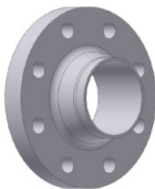
Gegenflansche / Counterflanges		Flansche (2 werden benötigt)		Anschluss		Gewicht	Preis
		Flange (you need 2 pcs.)		Connection		Weight	Price
		Artikel-Nr. / Article-No.	DN	Inch		[kg]	[EUR]
	Stahl, PN25/40 Schweißenden DIN2634 mit Feder EN1092-1 "C" mit Schrauben, Muttern und Dichtungen Steel, PN25/40 ISO Butt Weld Ends DIN2634 with tongue EN1092-1 "C" with bolts, nuts and gasket	FLADINF.015.SMD	15	1/2"		1,8	40,00 €
		FLADINF.020.SMD	20	3/4"		2,5	42,00 €
		FLADINF.025.SMD	25	1"		2,9	43,00 €
		FLADINF.032.SMD	32	1-1/4"		4,1	61,00 €
		FLADINF.040.SMD	40	1-1/2"		4,8	67,00 €
		FLADINF.050.SMD	50	2"		6,1	74,00 €
		FLADINF.065.SMD	65	2-1/2"		9,0	101,00 €
		FLADINF.080.SMD	80	3"		11,0	111,00 €
		FLADINF.100.SMD	100	4"		16,5	167,00 €
		FLADINF.125.SMD	125	5"		23,0	295,00 €
	FLADINF.150.SMD	150	6"		28,5	324,00 €	

Dichtungen / Gaskets		Flanschdichtung	Inhalt	Anschluss		Größe	Preis
		Gasket (Flange)	Content	Connection		Size	Price
		Artikel-Nr. / Article-No.	[pcs.]	DN	Inch	[mm]	[EUR]
Flanschdichtung für Nut EN1092-1 Form D Gasket (Flange) for groove EN1092-1 "D"	DI.FLANUT.015	1	15	1/2"	39x29x2	7,00 €	
	DI.FLANUT.020	1	20	3/4"	50x36x2	7,00 €	
	DI.FLANUT.025	1	25	1"	57x43x2	10,00 €	
	DI.FLANUT.032	1	32	1-1/4"	65x51x2	10,00 €	
	DI.FLANUT.040	1	40	1-1/2"	75x61x2	10,00 €	
	DI.FLANUT.050	1	50	2"	87x73x2	13,00 €	
	DI.FLANUT.065	1	65	2-1/2"	109x95x2	15,00 €	
	DI.FLANUT.080	1	80	3"	120x106x2	18,00 €	
	DI.FLANUT.100	1	100	4"	149x129x2	26,00 €	
	DI.FLANUT.125	1	125	5"	175x155x2	32,00 €	
	DI.FLANUT.150	1	150	6"	203x183x2	37,00 €	
	DI.FLANUT.200	1	200	8"	259x239x2	59,00 €	
	DI.FLANUT.250	1	250	10"	312x292x2	96,00 €	
	DI.FLANUT.300	1	300	12"	363x343x2	105,00 €	

Schrauben, Muttern / Bolts, Nuts		Schrauben/Mutternsatz	Inhalt	Anschluss		Größe	Preis
		Bolts/Nuts Kit	Content	Connection		Size	Price
		Artikel-Nr. / Article-No.	[pcs.]	DN	Inch	[mm]	[EUR]
Schrauben/Mutternsatz Bolts/Nuts Kit	SM.015.FLADIN	4	15-25	1/2" to 1"	M12x50	20,00 €	
	SM.032.FLADIN	4	32-50	1-1/4" to 2"	M16x55	39,00 €	
	SM.065.FLADIN	8	65	2-1/2"	M16x60	75,00 €	
	SM.080.FLADIN	8	80	3"	M16x65	75,00 €	
	SM.100.FLADIN	8	100	4"	M20x70	162,00 €	
	SM.125.FLADIN	8	125-150	5" to 6"	M24x80	373,00 €	
	SM.200.FLADIN	12	200	8"	M24x90	597,00 €	
	SM.250.FLADIN	12	250	10"	M27x90	832,00 €	
	SM.300.FLADIN	16	300	12"	M27x100	1.164,00 €	

Absperrklappen Butterfly Valves

handbetätigt, aus Stahl, PN25, mit Handhebel, auch für CO2 geeignet
manual actuated, made of steel, PN25, with lever, also suitable for CO2

Gegenflansche siehe nächste Seite
Counterflanges see next page

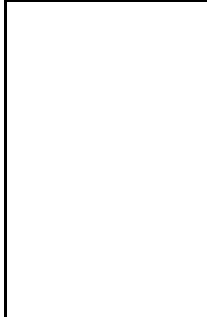
T53		Absperrklappe	Sitz	Anschluss		Kvs	Gewicht	Preis
		Butterfly Valve	Seat	Connection		Kvs	Weight	Price
		Article-No.	[mm]	DN	Inch	[m³/h]	[kg]	[EUR]
	Flanschschluß DIN2634 mit Nut EN1092-1 "D" With Flanged Connection DIN2634 with groove EN1092-1 "D"	53.050	40,0	50	2"	115	3,6	1.845,00 €
		53.065	51,0	65	2-1/2"	210	5,0	1.945,00 €
		53.080	66,0	80	3"	320	5,4	1.945,00 €
		53.100	90,0	100	4"	500	8,9	#NV
		53.125	113,0	125	5"	820	10,5	#NV
		53.150	141,0	150	6"	1200	13,5	4.337,00 €
		53.200	189,0	200	8"	2300	24,0	5.355,00 €
		53.250	236,0	250	10"	3600	40,4	7.936,00 €
		53.300	282,0	300	12"	5200	54,6	11.747,00 €
		53.350	326,0	350	14"	7300	74,4	14.531,00 €

Absperrklappen mit Antrieb Butterfly Valves with Actuator

Standard: mit pneumatischer Antrieb, 3/2-Wege-Luftmagnetventil, 230V/50Hz, Endlagenschalter, aus Stahl, PN25
Standard: with pneumatic actuator, 3/2-way-solenoid-valve, 230V/50Hz, limit switches, made of steel, PN25

Gegenflansche siehe nächste Seite
Counterflanges see next page

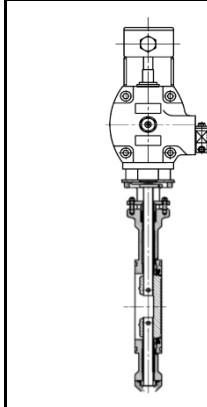
T530		Absperrklappe	Sitz	Anschluss		Kvs	Gewicht	Preis
		Butterfly Valve	Seat	Connection		Kvs	Weight	Price
		Artikel-Nr. / Article-No.	[mm]	DN	Inch	[m³/h]	[kg]	[EUR]
	Flanschschluß DIN2634 mit Nut EN1092-1 "D" With Flanged Connection DIN2634 with groove EN1092-1 "D"	530.050	40,0	50	2"	115	9,0	3.250,00 €
		530.065	51,0	65	2-1/2"	210	11,0	3.356,00 €
		530.080	66,0	80	3"	320	11,0	3.412,00 €
		530.100	90,0	100	4"	500	19,0	4.341,00 €
		530.125	113,0	125	5"	820	24,0	5.204,00 €
		530.150	141,0	150	6"	1200	26,0	6.320,00 €
		530.200	189,0	200	8"	2300	46,0	8.487,00 €
		530.250	236,0	250	10"	3600	96,0	13.479,00 €
		530.300	282,0	300	12"	5200	133,0	21.964,00 €
		530.350	326,0	350	14"	7300	208,0	28.087,00 €

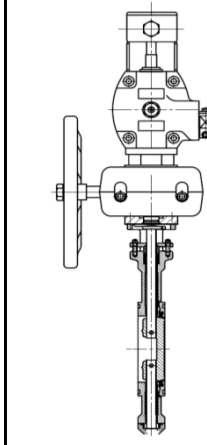
T530H		Absperrklappe	Sitz	Anschluss		Kvs	Gewicht	Preis
		Butterfly Valve	Seat	Connection		Kvs	Weight	Price
		Artikel-Nr. / Article-No.	[mm]	DN	Inch	[m³/h]	[kg]	[EUR]
	Handnotbetätigung Flanschschluß DIN2634 mit Nut EN1092-1 "D" Manual override With Flanged Connection DIN2634 with groove EN1092-1 "D"	530.050.H	40,0	50	2"	115	18,0	4.317,00 €
		530.065.H	51,0	65	2-1/2"	210	19,0	4.422,00 €
		530.080.H	66,0	80	3"	320	20,0	4.480,00 €
		530.100.H	90,0	100	4"	500	29,0	5.710,00 €
		530.125.H	113,0	125	5"	820	34,0	6.571,00 €
		530.150.H	141,0	150	6"	1200	36,0	7.686,00 €
		530.200.H	189,0	200	8"	2300	56,0	9.852,00 €
		530.250.H	236,0	250	10"	3600	110,0	15.188,00 €
		530.300.H	282,0	300	12"	5200	147,0	23.674,00 €

Gegenflansche finden sie auf der nächsten Seite!
Counterflanges you will find on the next page!

Absperrklappen mit Antrieb

Butterfly Valves with Actuator

mit elektrischen Antrieb, 230V/50Hz, Endlagenschalter, aus Stahl, PN25
with electric actuator, 230V/50Hz, limit switches, made of steel, PN25

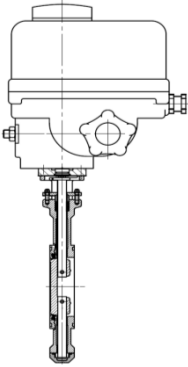
T730H		Absperrklappe	Sitz	Anschluss		Kvs	Gewicht	Preis
		Butterfly Valve	Seat	Connection		Kvs	Weight	Price
 <p>Handnotbetätigung Flanschanschluß DIN2634 mit Nut EN1092-1 "D" Manual override With Flanged Connection DIN2634 with groove EN1092-1 "D"</p>		Artikel-Nr. / Article-No.	[mm]	DN	Inch	[m³/h]	[kg]	[EUR]
		730.050.H	40,0	50	2"	115	9,0	3.855,00 €
		730.065.H	51,0	65	2-1/2"	210	11,0	3.965,00 €
		730.080.H	66,0	80	3"	320	11,0	4.312,00 €
		730.100.H	90,0	100	4"	500	15,0	5.086,00 €
		730.125.H	113,0	125	5"	820	18,0	6.212,00 €
		730.150.H	141,0	150	6"	1200	29,0	7.238,00 €
		730.200.H	189,0	200	8"	2300	40,0	9.067,00 €
		730.250.H	236,0	250	10"	3600	59,0	11.889,00 €
		730.300.H	282,0	300	12"	5200	75,0	16.079,00 €

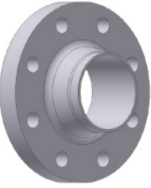
Gegenflansche / Counterflanges		für Absperrklappe			Gewicht	Preis
		for Butterflyvalve			Weight	Price
 <p>Gegenflansch Stahl, PN25/40 Schweißenden DIN2634 mit Feder EN1092-1 "C" Counterflange DIN2634 Steel, PN25 ISO Butt Weld Ends with tongue EN1092-1 "C"</p>		Artikel-Nr. / Article-No.	DN	Inch	[kg]	[EUR]
		FLADINF.050	50	2"		52,00 €
		FLADINF.065	65	2-1/2"		63,00 €
		FLADINF.080	80	3"		68,00 €
		FLADINF.100	100	4"		85,00 €
		FLADINF.125	125	5"		109,00 €
		FLADINF.150	150	6"		129,00 €
		FLADINF.200	200	8"		188,00 €
		FLADINF.250	250	10"		285,00 €
		FLADINF.300	300	12"		418,00 €
<p>Flanschdichtung Gasket Flange</p>		DI.FLANUT.050	50	2"		13,00 €
		DI.FLANUT.065	65	2-1/2"		15,00 €
		DI.FLANUT.080	80	3"		18,00 €
		DI.FLANUT.100	100	4"		26,00 €
		DI.FLANUT.125	125	5"		32,00 €
		DI.FLANUT.150	150	6"		37,00 €
		DI.FLANUT.200	200	8"		59,00 €
		DI.FLANUT.250	250	10"		96,00 €
DI.FLANUT.300	300	12"		105,00 €		
<p>Schrauben/Mutternsatz Bolts/Nuts Kit</p>		SM.050.T53	50	2"		43,00 €
		SM.065.T53	65	2-1/2"		43,00 €
		SM.080.T53	80	3"		87,00 €
		SM.100.T53	100	4"		184,00 €
		SM.125.T53	125	5"		281,00 €
		SM.150.T53	150	6"		293,00 €
		SM.200.T53	200	8"		475,00 €
		SM.250.T53	250	10"		948,00 €
SM.300.T53	300	12"		1.261,00 €		

Regelventile Regulating Valve, BW

Standard: handbetätigt, aus Stahl, mit ISO Anschweißenden, Kappe, PN25
Standard: manual actuated, made of steel, with butt weld ends ISO, cap, PN25
Alternative: Anschweißenden mit Schweißfase nach ANSI, Schedule, mit Handrad
Alternative: butt weld ends according ANSI, Schedule, with handwheel

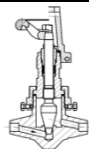
T5-R		Regelventil, Durchgang	Anschluss		Kvs	Gewicht	Preis
		Regulating Valve, Globe	Connection		Kvs	Weight	Price
		Artikel-Nr. / Article-No.	DN	Inch	[m³/h]	[kg]	[EUR]
		Oberteil geschraubt Screwed bonnet		5.006-R.K	6	1/4"	0,70
5.008-R.K	8			5/16"	1,36	0,9	117,00 €
5.012-R.K	12			1/2"	2,15	0,9	on request

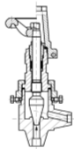
T6-R		Regelventil, Eck	Anschluss		Kvs	Gewicht	Preis
		Regulating Valve, Angle	Connection		Kvs	Weight	Price
		Artikel-Nr. / Article-No.	DN	Inch	[m³/h]	[kg]	[EUR]
		Oberteil geschraubt Screwed bonnet		6.006-R.K	6	1/4"	0,94
6.008-R.K	8			5/16"	2,12	0,8	117,00 €
6.012-R.K	12			1/2"	3,60	0,8	on request

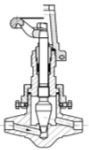
T5-R.x		Nadelventil, Durchgang	Anschluss		Kvs	Gewicht	Preis
		Needle Valve, Globe	Connection		Kvs	Weight	Price
		Artikel-Nr. / Article-No.	DN	Inch	[m³/h]	[kg]	[EUR]
		Oberteil geschraubt Screwed bonnet		5.006-R.3.K	15	1/2"	0,24
5.006-R.5.K	15			1/2"	0,53	0,6	125,00 €
5.006-R.7.K	15			1/2"	0,78	0,6	125,00 €

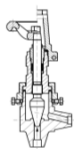
T6-R.x		Nadelventil, Eck	Anschluss		Kvs	Gewicht	Preis
		Needle Valve, Angle	Connection		Kvs	Weight	Price
		Artikel-Nr. / Article-No.	DN	Inch	[m³/h]	[kg]	[EUR]
		Oberteil geschraubt Screwed bonnet		6.006-R.3.K	15	1/2"	0,28
6.006-R.5.K	15			1/2"	0,53	0,5	125,00 €
6.006-R.7.K	15			1/2"	0,83	0,5	125,00 €

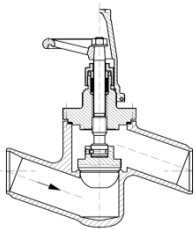
T5F-R		Regelventil, Durchgang	Anschluss		Kvs	Gewicht	Preis
		Regulating Valve, Globe	Connection		Kvs	Weight	Price
		Artikel-Nr. / Article-No.	DN	Inch	[m³/h]	[kg]	[EUR]
		Oberteil geflanscht Bolted bonnet		5.015.F-R.K	15	1/2"	3,8
5.020.F-R.K	20			3/4"	6,1	1,7	145,00 €
5.025.F-R.K	25			1"	8,8	3,0	173,00 €
5.032.F-R.K	32			1-1/4"	12,7	3,5	199,00 €
5.040.F-R.K	40			1-1/2"	24,0	4,8	239,00 €
5.050.F-R.K	50			2"	34,8	6,6	305,00 €
5.065.F-R.K	65			2-1/2"	73,4	16,0	449,00 €
5.080.F-R.K	80			3"	96,1	23,8	560,00 €
5.100.F-R.K	100			4"	166,7	32,0	704,00 €
5.125.F-R.K	125			5"	252,6	63,0	1.158,00 €
5.150.F-R.K	150	6"	397,0	108,0	1.608,00 €		
5.200.F-R.K	200	8"	630,0	174,0	2.613,00 €		

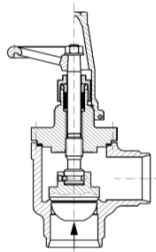
T6F-R		Regelventil, Eck	Anschluss		Kvs	Gewicht	Preis
		Regulating Valve, Angle	Connection		Kvs	Weight	Price
		Artikel-Nr. / Article-No.	DN	Inch	[m³/h]	[kg]	[EUR]
		Oberteil geflanscht Bolted bonnet		6.015.F-R.K	15	1/2"	5,3
6.020.F-R.K	20			3/4"	8,9	1,4	143,00 €
6.025.F-R.K	25			1"	14,0	2,7	165,00 €
6.032.F-R.K	32			1-1/4"	23,8	2,9	189,00 €
6.040.F-R.K	40			1-1/2"	37,8	4,1	228,00 €
6.050.F-R.K	50			2"	55,4	5,3	258,00 €
6.065.F-R.K	65			2-1/2"	88,1	14,4	415,00 €
6.080.F-R.K	80			3"	115,3	15,3	532,00 €
6.100.F-R.K	100			4"	200,0	21,0	623,00 €
6.125.F-R.K	125			5"	303,1	48,0	1.013,00 €
6.150.F-R.K	150			6"	476,4	86,0	1.324,00 €
6.200.F-R.K	200			8"	756,0	117,0	2.416,00 €

Regelventile Regulating Valves, BW

Standard: handbetätigt, aus Stahl, mit ISO Anschweißenden, Kappe, PN25
Standard: manual actuated, made of steel, with butt weld ends ISO, cap, PN25
Alternative: Anschweißenden mit Schweißfase nach ANSI, Schedule, mit Handrad
Alternative: butt weld ends according ANSI, Schedule, with handwheel

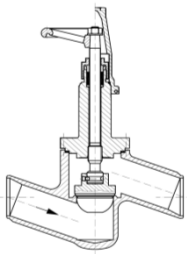
T5F.L-R		Regelventil, Durchgang	Anschluss		Kvs	Gewicht	Preis
		Regulating Valve, Globe	Connection		Kvs	Weight	Price
		Artikel-Nr. / Article-No.	DN	Inch	[m³/h]	[kg]	[EUR]
		Verlängertes Oberteil					
Extended bonnet							
5.015.F.L-R.K	15	1/2"	3,8	1,8	156,00 €		
5.020.F.L-R.K	20	3/4"	6,1	2,0	162,00 €		
5.025.F.L-R.K	25	1"	8,8	3,5	199,00 €		
5.032.F.L-R.K	32	1-1/4"	12,7	3,9	227,00 €		
5.040.F.L-R.K	40	1-1/2"	24,0	5,3	257,00 €		
5.050.F.L-R.K	50	2"	34,8	7,2	323,00 €		
5.065.F.L-R.K	65	2-1/2"	73,4	18,9	528,00 €		
5.080.F.L-R.K	80	3"	96,1	28,6	640,00 €		
5.100.F.L-R.K	100	4"	166,7	37,0	783,00 €		
5.125.F.L-R.K	125	5"	252,6	67,0	1.443,00 €		
5.150.F.L-R.K	150	6"	397,0	124,0	1.891,00 €		
5.200.F.L-R.K	200	8"	630,0	180,0	2.975,00 €		

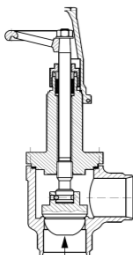
T6F.L-R		Regelventil, Eck	Anschluss		Kvs	Gewicht	Preis
		Regulating Valve, Angle	Connection		Kvs	Weight	Price
		Artikel-Nr. / Article-No.	DN	Inch	[m³/h]	[kg]	[EUR]
		Verlängertes Oberteil					
Extended bonnet							
6.015.F.L-R.K	15	1/2"	5,3	1,5	152,00 €		
6.020.F.L-R.K	20	3/4"	8,9	1,7	159,00 €		
6.025.F.L-R.K	25	1"	14,0	3,0	191,00 €		
6.032.F.L-R.K	32	1-1/4"	23,8	3,5	218,00 €		
6.040.F.L-R.K	40	1-1/2"	37,8	4,4	247,00 €		
6.050.F.L-R.K	50	2"	55,4	5,8	278,00 €		
6.065.F.L-R.K	65	2-1/2"	88,1	21,0	494,00 €		
6.080.F.L-R.K	80	3"	115,3	21,8	610,00 €		
6.100.F.L-R.K	100	4"	200,0	27,0	703,00 €		
6.125.F.L-R.K	125	5"	303,1	52,0	1.300,00 €		
6.150.F.L-R.K	150	6"	476,4	104,0	1.608,00 €		
6.200.F.L-R.K	200	8"	756,0	123,0	2.778,00 €		

Regel/Absperrventile Regulating /Shut-Off Valves, BW

Standard: handbetätigt, aus Stahl, mit ISO Anschweißenden, Kappe, PN25
Standard: manual actuated, made of steel, with butt weld ends ISO, cap, PN25
Alternative: Anschweißenden mit Schweißfase nach ANSI, Schedule, mit Handrad
Alternative: butt weld ends according ANSI, Schedule, with handwheel

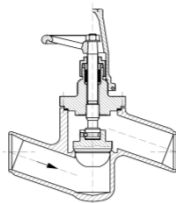
T5F-R/AV		Regelventil, Durchgang	Anschluss		Kvs	Gewicht	Preis
		Regulating Valve, Globe	Connection		Kvs	Weight	Price
		Artikel-Nr. / Article-No.	DN	Inch	[m³/h]	[kg]	[EUR]
		Oberteil geflanscht					
Bolted bonnet							
5.015.F-R/AV.K	15	1/2"	3,8	1,4	154,00 €		
5.020.F-R/AV.K	20	3/4"	6,1	1,7	161,00 €		
5.025.F-R/AV.K	25	1"	8,8	3,0	187,00 €		
5.032.F-R/AV.K	32	1-1/4"	12,7	3,5	219,00 €		
5.040.F-R/AV.K	40	1-1/2"	24,0	4,8	264,00 €		
5.050.F-R/AV.K	50	2"	34,8	6,6	336,00 €		

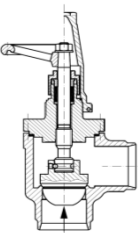
T6F-R/AV		Regelventil, Eck	Anschluss		Kvs	Gewicht	Preis
		Regulating Valve, Angle	Connection		Kvs	Weight	Price
		Artikel-Nr. / Article-No.	DN	Inch	[m³/h]	[kg]	[EUR]
		Oberteil geflanscht					
Bolted bonnet							
6.015.F-R/AV.K	15	1/2"	5,3	1,3	151,00 €		
6.020.F-R/AV.K	20	3/4"	8,9	1,4	161,00 €		
6.025.F-R/AV.K	25	1"	14,0	2,7	179,00 €		
6.032.F-R/AV.K	32	1-1/4"	23,8	2,9	219,00 €		
6.040.F-R/AV.K	40	1-1/2"	37,8	4,1	264,00 €		
6.050.F-R/AV.K	50	2"	55,4	5,3	336,00 €		
6.065.F-R/AV.K	65	2-1/2"	88,1	16,0	479,00 €		

Regelventile FAB A

Regulating Valves Bellows

Standard: handbetätigt, aus Stahl, mit ISO Anschweißenden, Kappe, PN25

Standard: manual actuated, made of steel, with butt weld ends ISO, cap, PN25

Alternative: Anschweißenden mit Schweißfase nach ANSI, Schedule, mit Handrad

Alternative: butt weld ends according ANSI, Schedule, with handwheel

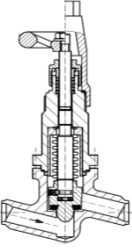
T5F.FA-R		Absperrventil, Durchgang	Anschluss		Kvs	Gewicht	Preis
		Shut Off Valve, Globe	Connection		Kvs	Weight	Price
 Spindelabdichtung: Faltenbalg Oberteil geflanscht Stem Sealing: Bellows Seal Bolted bonnet		Artikel-Nr. / Article-No.	DN	Inch	[m³/h]	[kg]	[EUR]
		5.015.F.FA-R.K	15	1/2"	3,8	1,8	422,00 €
5.020.F.FA-R.K	20	3/4"	6,1	2,1	441,00 €		
5.025.F.FA-R.K	25	1"	8,8	3,6	507,00 €		
5.032.F.FA-R.K	32	1-1/4"	12,7	4,0	577,00 €		
5.040.F.FA-R.K	40	1-1/2"	24,0	5,6	724,00 €		
5.050.F.FA-R.K	50	2"	34,8	8,0	829,00 €		
5.065.F.FA-R.K	65	2-1/2"	73,4	18,2	1.510,00 €		
5.080.F.FA-R.K	80	3"	96,1	26,6	1.732,00 €		
5.100.F.FA-R.K	100	4"	166,7	39,0	2.054,00 €		
5.125.F.FA-R.K	125	5"	252,6	74,0	4.695,00 €		
5.150.F.FA-R.K	150	6"	397,0	130,0	5.885,00 €		
5.200.F.FA-R.K	200	8"	630,0	215,0	8.580,00 €		

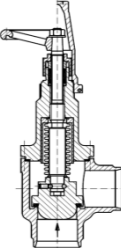
T6F.FA-R		Absperrventil, Eck	Anschluss		Kvs	Gewicht	Preis
		Shut Off Valve, Angle	Connection		Kvs	Weight	Price
 Spindelabdichtung: Faltenbalg Oberteil geflanscht Stem Sealing: Bellows Seal Bolted bonnet		Artikel-Nr. / Article-No.	DN	Inch	[m³/h]	[kg]	[EUR]
		6.015.F.FA-R.K	15	1/2"	5,3	1,6	420,00 €
6.020.F.FA-R.K	20	3/4"	8,9	1,7	439,00 €		
6.025.F.FA-R.K	25	1"	14,0	3,2	499,00 €		
6.032.F.FA-R.K	32	1-1/4"	23,8	3,7	568,00 €		
6.040.F.FA-R.K	40	1-1/2"	37,8	5,0	715,00 €		
6.050.F.FA-R.K	50	2"	55,4	6,3	783,00 €		
6.065.F.FA-R.K	65	2-1/2"	88,1	21,0	1.478,00 €		
6.080.F.FA-R.K	80	3"	115,3	21,9	1.705,00 €		
6.100.F.FA-R.K	100	4"	200,0	27,4	1.976,00 €		
6.125.F.FA-R.K	125	5"	303,1	59,0	4.555,00 €		
6.150.F.FA-R.K	150	6"	476,4	110,0	5.605,00 €		
6.200.F.FA-R.K	200	8"	756,0	158,0	8.383,00 €		

Regelventile CO²

Regulating Valves CO², BW

Standard: handbetätigt, aus Stahl, mit ISO Anschweißenden, Kappe, PN40

Standard: manual actuated, made of steel, with butt weld ends ISO, cap, PN40

Alternative: Anschweißenden mit Schweißfase nach ANSI, Schedule, mit Handrad

Alternative: butt weld ends according ANSI, Schedule, with handwheel

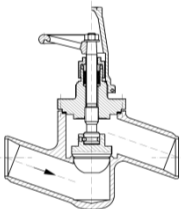
T5F-CO2-R		Regelventil, Durchgang	Anschluss		Kvs	Gewicht	Preis
		Regulating Valve, Globe	Connection		Kvs	Weight	Price
		Artikel-Nr. / Article-No.	DN	Inch	[m ³ /h]	[kg]	[EUR]
		Oberteil geflanscht Für trockenes CO ₂ Bolted bonnet For dry CO ₂		5.015.F-CO2-R.K	15	1/2"	3,8
5.020.F-CO2-R.K	20			3/4"	6,1	1,7	160,00 €
5.025.F-CO2-R.K	25			1"	8,8	3,0	192,00 €
5.032.F-CO2-R.K	32			1-1/4"	12,7	3,5	223,00 €
5.040.F-CO2-R.K	40			1-1/2"	24,0	4,8	267,00 €
5.050.F-CO2-R.K	50			2"	34,8	6,6	339,00 €
5.065.F-CO2-R.K	65			2-1/2"	73,4	16,0	515,00 €
5.080.F-CO2-R.K	80			3"	96,1	23,8	629,00 €
5.100.F-CO2-R.K	100			4"	166,7	32,0	780,00 €
5.125.F-CO2-R.K	125			5"	252,6	63,0	1.276,00 €
5.150.F-CO2-R.K	150	6"	397,0	108,0	1.777,00 €		

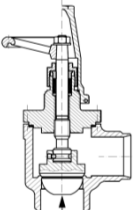
T6F-CO2-R		Regelventil, Eck	Anschluss		Kvs	Gewicht	Preis	
		Regulating Valve, Angle	Connection		Kvs	Weight	Price	
		Artikel-Nr. / Article-No.	[mm]	DN	Inch	[m ³ /h]	[kg]	[EUR]
		Oberteil geflanscht Für trockenes CO ₂ Bolted bonnet For dry CO ₂		6.015.F-CO2-R.K		15	1/2"	5,3
6.020.F-CO2-R.K				20	3/4"	8,9	1,4	157,00 €
6.025.F-CO2-R.K				25	1"	14,0	2,7	184,00 €
6.032.F-CO2-R.K				32	1-1/4"	23,8	2,9	213,00 €
6.040.F-CO2-R.K				40	1-1/2"	37,8	4,1	257,00 €
6.050.F-CO2-R.K				50	2"	55,4	5,3	290,00 €
6.065.F-CO2-R.K				65	2-1/2"	88,1	14,4	478,00 €
6.080.F-CO2-R.K				80	3"	115,3	15,3	601,00 €
6.100.F-CO2-R.K				100	4"	200,0	21,0	696,00 €
6.125.F-CO2-R.K				125	5"	303,1	48,0	#NV
6.150.F-CO2-R.K				150	6"	476,4	86,0	1.479,00 €

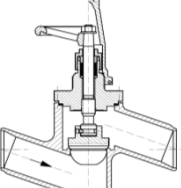
T5F.L-CO2-R		Regelventil, Durchgang	Anschluss		Kvs	Gewicht	Preis
		Regulating Valve, Globe	Connection		Kvs	Weight	Price
		Artikel-Nr. / Article-No.	DN	Inch	[m ³ /h]	[kg]	[EUR]
		Oberteil geflanscht Für trockenes CO ₂ Verlängertes Oberteil Bolted bonnet For dry CO ₂ Extended bonnet		5.015.F.L-CO2-R.K	15	1/2"	3,8
5.020.F.L-CO2-R.K	20			3/4"	6,1	2,0	183,00 €
5.025.F.L-CO2-R.K	25			1"	8,8	3,5	228,00 €
5.032.F.L-CO2-R.K	32			1-1/4"	12,7	3,9	258,00 €
5.040.F.L-CO2-R.K	40			1-1/2"	24,0	5,3	300,00 €
5.050.F.L-CO2-R.K	50			2"	34,8	7,2	370,00 €
5.065.F.L-CO2-R.K	65			2-1/2"	73,4	18,9	607,00 €
5.080.F.L-CO2-R.K	80			3"	96,1	28,6	723,00 €
5.100.F.L-CO2-R.K	100			4"	166,7	37,0	874,00 €
5.125.F.L-CO2-R.K	125			5"	252,6	67,0	1.609,00 €
5.150.F.L-CO2-R.K	150			6"	397,0	124,0	2.106,00 €

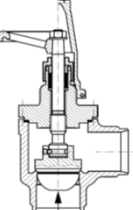
T6F.L-CO2-R		Regelventil, Eck	Anschluss		Kvs	Gewicht	Preis
		Regulating Valve, Angle	Connection		Kvs	Weight	Price
		Artikel-Nr. / Article-No.	DN	Inch	[m ³ /h]	[kg]	[EUR]
		Oberteil geflanscht Für trockenes CO ₂ Verlängertes Oberteil Bolted bonnet For dry CO ₂ Extended bonnet		6.015.F.L-CO2-R.K	15	1/2"	5,3
6.020.F.L-CO2-R.K	20			3/4"	8,9	1,7	181,00 €
6.025.F.L-CO2-R.K	25			1"	14,0	3,0	221,00 €
6.032.F.L-CO2-R.K	32			1-1/4"	23,8	3,5	247,00 €
6.040.F.L-CO2-R.K	40			1-1/2"	37,8	4,4	289,00 €
6.050.F.L-CO2-R.K	50			2"	55,4	5,8	322,00 €
6.065.F.L-CO2-R.K	65			2-1/2"	88,1	21,0	573,00 €
6.080.F.L-CO2-R.K	80			3"	115,3	21,8	694,00 €
6.100.F.L-CO2-R.K	100			4"	200,0	27,0	789,00 €
6.125.F.L-CO2-R.K	125			5"	303,1	52,0	1.456,00 €
6.150.F.L-CO2-R.K	150			6"	476,4	104,0	1.810,00 €

Expansionsventile Expansion Valves

mit elektrischen Antrieb
with electric actuator

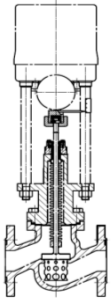
T150.EXP		Expansionsventil	Sitz	Anschluss		Kvs	Gewicht	Preis
		Expansion Valve	Seat	Connection		Kvs	Weight	Price
 <p>Parabolkegel DN15-32 Lochkegel DN40-200 Spannung 230V/50Hz Endlagenschalter Stellungsregler 4...20mA Schließdruck dp=25 bar Parabolic Cobe DN15-32 Perforated Cone DN40-200 Voltage: 230V/50Hz, 1ph Limit Switches Positioner 4...20mA Closing Pressure dp=25 bar</p>		Artikel-Nr. / Article-No.	[mm]	DN	Inch	[m³/h]	[kg]	[EUR]
				150.EXP.015.000.25	4	15	1/2"	0,25
		150.EXP.020.000.25	4	20	3/4"	0,50	11,0	on request
		150.EXP.025.001.25	8	25	1"	1,00	12,0	on request
		150.EXP.032.002.25	8	32	1-1/4"	1,70	14,0	on request
		150.EXP.040.003.25	15	40	1-1/2"	2,70	17,0	on request
		150.EXP.050.005.25	20	50	2"	4,80	19,0	on request
		150.EXP.065.008.25	25	65	2-1/2"	7,60	25,0	on request
		150.EXP.080.013.25	32	80	3"	13,00	39,0	on request
		150.EXP.100.020.25	40	100	4"	20,00	50,0	on request
		150.EXP.125.030.25	50	125	5"	30,00	68,0	on request
		150.EXP.150.052.25	65	150	6"	52,00	92,0	on request
		150.EXP.200.078.25	80	200	8"	78,00	202,0	on request

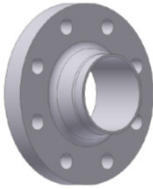
Gegenflansche / Counterflanges		Flansche (2 werden benötigt)		Anschluss		Gewicht	Preis
		Flange (you need 2 pcs.)		Connection		Weight	Price
 <p>Stahl, PN25/40 Schweißenden DIN2634 mit Feder EN1092-1 "C" mit Schrauben, Muttern und Dichtungen Steel, PN25/40 ISO Butt Weld Ends DIN2634 with tongue EN1092-1 "C" with bolts, nuts and gasket</p>		Artikel-Nr. / Article-No.		DN	Inch	[kg]	[EUR]
				FLADINF.015.SMD		15	1/2"
		FLADINF.020.SMD		20	3/4"	2,5	42,00 €
		FLADINF.025.SMD		25	1"	2,9	43,00 €
		FLADINF.032.SMD		32	1-1/4"	4,1	61,00 €
		FLADINF.040.SMD		40	1-1/2"	4,8	67,00 €
		FLADINF.050.SMD		50	2"	6,1	74,00 €
		FLADINF.065.SMD		65	2-1/2"	9,0	101,00 €
		FLADINF.080.SMD		80	3"	11,0	111,00 €
		FLADINF.100.SMD		100	4"	16,5	167,00 €
		FLADINF.125.SMD		125	5"	23,0	295,00 €
		FLADINF.150.SMD		150	6"	28,5	324,00 €
		FLADINF.200.SMD		200	8"	49,00	490,00 €

Schmutzsammler Strainer, BW

Standard: aus Stahl, PN25, mit ISO Anschweißenden, Maschenweite 0,5mm, (auch für CO2 geeignet)
Standard: made of steel, PN25, with butt weld ends ISO, mesh size 0.5mm, (also suitable for CO2)

Alternative: Anschweißenden mit Schweißfase nach ANSI, Schedule
Alternative: butt weld ends according ANSI, Schedule

Alternative: Maschenweite 0,1mm oder 0,25mm
Alternative: mesh size 0.1mm or 0.25mm

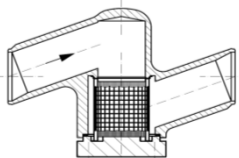
T5F-SS		Schmutzsammler, Durchg.	Masche	Anschluss		Kvs	Gewicht	Preis
		Strainer, Globe	Mesh	Connection		Kvs	Weight	Price
 <p>Oberteil geflanscht Bolted bonnet</p> <p>Bestellbeispiel / how to order: 5.040.F-SS.Y Y=5 0,5mm Y=1 0,1mm Y=25 0,25mm</p>		Artikel-Nr. / Article-No.	[mm]	DN	Inch	[m³/h]	[kg]	[EUR]
				5.015.F-SS.5	0,5	15	1/2"	5,8
		5.020.F-SS.5	0,5	20	3/4"	7,3	1,2	129,00 €
		5.025.F-SS.5	0,5	25	1"	11,8	2,0	142,00 €
		5.032.F-SS.5	0,5	32	1-1/4"	15,5	2,4	156,00 €
		5.040.F-SS.5	0,5	40	1-1/2"	24,9	3,7	173,00 €
		5.050.F-SS.5	0,5	50	2"	33,4	5,2	224,00 €
		5.065.F-SS.5	0,5	65	2-1/2"	59,6	14,2	386,00 €
		5.080.F-SS.5	0,5	80	3"	83,2	15,8	438,00 €
		5.100.F-SS.5	0,5	100	4"	135,0	22,2	527,00 €
		5.125.F-SS.5	0,5	125	5"	242,0	44,0	946,00 €
		5.150.F-SS.5	0,5	150	6"	358,0	50,0	1.355,00 €
		5.200.F-SS.5	0,5	200	8"	544,0	120,0	2.087,00 €

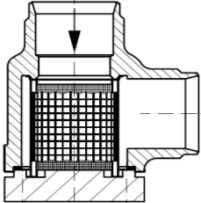
T6F-SS		Schmutzsammler, Eck	Masche	Anschluss		Kvs	Gewicht	Preis
		Strainer, Angle	Mesh	Connection		Kvs	Weight	Price
 <p>Oberteil geflanscht Bolted bonnet</p> <p>Bestellbeispiel / how to order: 5.040.F-SS.Y Y=5 0,5mm Y=1 0,1mm Y=25 0,25mm</p>		Artikel-Nr. / Article-No.	[mm]	DN	Inch	[m³/h]	[kg]	[EUR]
				6.015.F-SS.5	0,5	15	1/2"	4,9
		6.020.F-SS.5	0,5	20	3/4"	8,0	0,9	126,00 €
		6.025.F-SS.5	0,5	25	1"	13,1	1,7	134,00 €
		6.032.F-SS.5	0,5	32	1-1/4"	26,2	2,0	145,00 €
		6.040.F-SS.5	0,5	40	1-1/2"	27,1	3,0	162,00 €
		6.050.F-SS.5	0,5	50	2"	50,4	3,8	177,00 €
		6.065.F-SS.5	0,5	65	2-1/2"	71,9	9,3	355,00 €
		6.080.F-SS.5	0,5	80	3"	124,0	9,6	410,00 €
		6.100.F-SS.5	0,5	100	4"	185,0	13,4	446,00 €
		6.125.F-SS.5	0,5	125	5"	319,0	28,0	798,00 €
		6.150.F-SS.5	0,5	150	6"	535,0	39,0	1.073,00 €
		6.200.F-SS.5	0,5	200	8"	816,0	65,0	1.892,00 €

Bilder sind nur zur Orientierung!
Pictures are for orientation only!

Rückschlagventile Check Valve, BW

TF: Für die Flüssigkeitsleitung und Heissgas-Abtauung
TF: For liquid line and hotgas-defrosting

Standard: aus Stahl, PN25, mit ISO Anschweißenden
Standard: made of steel, PN25, with butt weld ends ISO

Alternative: Anschweißenden mit Schweißfase nach ANSI, Schedule
Alternative: butt weld ends according ANSI, Schedule

Auslegung mit V.S.P. Valve Selection Program erforderlich
Selection by V.S.P. Valve Selection Program required

T5F-RUV/TF		Rückschlagventil, Durchg.	Anschluss		Kvs	Gewicht	Preis
		Check Valve, Globe	Connection		Kvs	Weight	Price
		Artikel-Nr. / Article-No.	DN	Inch	[m³/h]	[kg]	[EUR]
	Oberteil geflanscht Bolted bonnet	5.015.F-RUV/TF	15	1/2"	4,0	0,9	121,00 €
		5.020.F-RUV/TF	20	3/4"	7,0	1,2	127,00 €
		5.025.F-RUV/TF	25	1"	13,0	2,1	151,00 €
		5.032.F-RUV/TF	32	1-1/4"	13,0	2,4	176,00 €
		5.040.F-RUV/TF	40	1-1/2"	23,0	3,8	206,00 €
		5.050.F-RUV/TF	50	2"	31,0	5,1	267,00 €
		5.065.F-RUV/TF	65	2-1/2"	65,0	15,5	417,00 €
		5.080.F-RUV/TF	80	3"	94,0	17,3	483,00 €
		5.100.F-RUV/TF	100	4"	142,0	23,8	608,00 €

T6F-RUV/TF		Rückschlagventil, Eck	Anschluss		Kvs	Gewicht	Preis
		Check Valve, Angle	Connection		Kvs	Weight	Price
		Artikel-Nr. / Article-No.	DN	Inch	[m³/h]	[kg]	[EUR]
	Oberteil geflanscht Bolted bonnet	6.015.F-RUV/TF	15	1/2"	5,0	0,8	117,00 €
		6.020.F-RUV/TF	20	3/4"	7,0	1,0	125,00 €
		6.025.F-RUV/TF	25	1"	14,0	1,8	143,00 €
		6.032.F-RUV/TF	32	1-1/4"	21,0	2,1	166,00 €
		6.040.F-RUV/TF	40	1-1/2"	23,0	3,2	194,00 €
		6.050.F-RUV/TF	50	2"	53,0	4,2	223,00 €
		6.065.F-RUV/TF	65	2-1/2"	69,0	10,0	384,00 €
		6.080.F-RUV/TF	80	3"	140,0	17,8	454,00 €
		6.100.F-RUV/TF	100	4"	188,0	23,4	528,00 €

Rückschlagventile Check Valve, BW

TG: Nur für Verdichterdruckleitung und Sauggasleitung
TG: Only for compressor discharge line and suction line

Standard: aus Stahl, PN25, mit ISO Anschweißenden
Standard: made of steel, PN25, with butt weld ends ISO

Alternative: Anschweißenden mit Schweißfase nach ANSI, Schedule
Alternative: butt weld ends according ANSI, Schedule

Auslegung mit V.S.P. Valve Selection Program erforderlich
Selection by V.S.P. Valve Selection Program required

T5F-RUV/TG		Rückschlagventil, Durchg.	Anschluss		Kvs	Gewicht	Preis
		Check Valve, Globe	Connection		Kvs	Weight	Price
		Artikel-Nr. / Article-No.	DN	Inch	[m³/h]	[kg]	[EUR]
	Oberteil geflanscht Bolted bonnet	5.015.F-RUV/TG	15	1/2"	4,0	0,9	121,00 €
		5.020.F-RUV/TG	20	3/4"	7,0	1,2	127,00 €
		5.025.F-RUV/TG	25	1"	13,0	2,1	151,00 €
		5.032.F-RUV/TG	32	1-1/4"	13,0	2,4	176,00 €
		5.040.F-RUV/TG	40	1-1/2"	23,0	3,8	206,00 €
		5.050.F-RUV/TG	50	2"	31,0	5,1	267,00 €
		5.065.F-RUV/TG	65	2-1/2"	65,0	15,5	417,00 €
		5.080.F-RUV/TG	80	3"	94,0	17,3	483,00 €
		5.100.F-RUV/TG	100	4"	142,0	23,8	608,00 €

T6F-RUV/TG		Rückschlagventil, Eck	Anschluss		Kvs	Gewicht	Preis
		Check Valve, Angle	Connection		Kvs	Weight	Price
		Artikel-Nr. / Article-No.	DN	Inch	[m³/h]	[kg]	[EUR]
	Oberteil geflanscht Bolted bonnet	6.015.F-RUV/TG	15	1/2"	5,0	0,8	117,00 €
		6.020.F-RUV/TG	20	3/4"	7,0	1,0	125,00 €
		6.025.F-RUV/TG	25	1"	14,0	1,8	143,00 €
		6.032.F-RUV/TG	32	1-1/4"	21,0	2,1	166,00 €
		6.040.F-RUV/TG	40	1-1/2"	23,0	3,2	194,00 €
		6.050.F-RUV/TG	50	2"	53,0	4,2	223,00 €
		6.065.F-RUV/TG	65	2-1/2"	69,0	10,0	384,00 €
		6.080.F-RUV/TG	80	3"	140,0	17,8	454,00 €
		6.100.F-RUV/TG	100	4"	188,0	23,4	528,00 €

Absperr/Rückschlagventile Stop/Check Valve, BW

Auslegung mit V.S.P. Valve Selection Program erforderlich
Selection by V.S.P. Valve Selection Program required

Standard: aus Stahl, PN25, mit ISO Anschweißenden, Kappe
Standard: made of steel, PN25, with butt weld ends ISO, cap

Alternative: Anschweißenden mit Schweißfase nach ANSI, Schedule
Alternative: butt weld ends according ANSI, Schedule

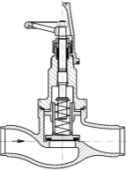
T5F.RUV/AV		Rückschlagventil, Durchg,	Anschluss		Kvs	Gewicht	Preis	
		Check Valve, Globe	Connection		Kvs	Weight	Price	
		Oberteil geflanscht Bolted bonnet	Artikel-Nr. / Article-No.	DN	Inch	[m³/h]	[kg]	[EUR]
			5.015.F.RUV/AV.K	15	1/2"		1,7	276,00 €
5.020.F.RUV/AV.K	20	3/4"		2,2	303,00 €			
5.025.F.RUV/AV.K	25	1"		3,6	325,00 €			
5.032.F.RUV/AV.K	32	1-1/4"		4,3	339,00 €			
5.040.F.RUV/AV.K	40	1-1/2"		5,5	377,00 €			
5.050.F.RUV/AV.K	50	2"		6,6	654,00 €			
5.065.F.RUV/AV.K	65	2-1/2"		24,2	861,00 €			
5.080.F.RUV/AV.K	80	3"		25,9	1.024,00 €			
5.100.F.RUV/AV.K	100	4"		32,7	1.376,00 €			

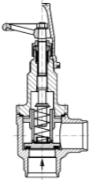
T6F.RUV/AV		Rückschlagventil, Eck	Anschluss		Kvs	Gewicht	Preis	
		Check Valve, Angle	Connection		Kvs	Weight	Price	
		Oberteil geflanscht Bolted bonnet	Artikel-Nr. / Article-No.	DN	Inch	[m³/h]	[kg]	[EUR]
			6.015.F.RUV/AV.K	15	1/2"	3,2	1,6	272,00 €
6.020.F.RUV/AV.K	20	3/4"	5,7	2,0	300,00 €			
6.025.F.RUV/AV.K	25	1"	8,9	3,4	317,00 €			
6.032.F.RUV/AV.K	32	1-1/4"	14,5	3,7	328,00 €			
6.040.F.RUV/AV.K	40	1-1/2"	22,7	4,6	340,00 €			
6.050.F.RUV/AV.K	50	2"	35,4	5,7	572,00 €			
6.065.F.RUV/AV.K	65	2-1/2"	59,8	18,0	828,00 €			
6.080.F.RUV/AV.K	80	3"	90,7	18,4	996,00 €			
6.100.F.RUV/AV.K	100	4"	141,7	23,7	1.298,00 €			

Absperr/Rückschlagventile CO² Stop/Check Valve CO², BW

Auslegung mit V.S.P. Valve Selection Program erforderlich
Selection by V.S.P. Valve Selection Program required

Standard: aus Stahl, PN40, mit ISO Anschweißenden, Kappe
Standard: made of steel, PN40, with butt weld ends ISO, cap

Alternative: Anschweißenden mit Schweißfase nach ANSI, Schedule
Alternative: butt weld ends according ANSI, Schedule

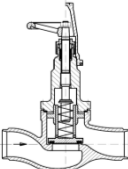
T5F.RUV/AV-CO2		Rückschlagventil, Durchg,	Anschluss		Kvs	Gewicht	Preis	
		Check Valve, Globe	Connection		Kvs	Weight	Price	
		Oberteil geflanscht Bolted bonnet	Artikel-Nr. / Article-No.	DN	Inch	[m³/h]	[kg]	[EUR]
			5.015.F.RUV/AV-CO2.K	15	1/2"		1,7	#NV
5.020.F.RUV/AV-CO2.K	20	3/4"		2,2	329,00 €			
5.025.F.RUV/AV-CO2.K	25	1"		3,6	#NV			
5.032.F.RUV/AV-CO2.K	32	1-1/4"		4,3	#NV			
5.040.F.RUV/AV-CO2.K	40	1-1/2"		5,5	#NV			
5.050.F.RUV/AV-CO2.K	50	2"		6,6	#NV			
5.065.F.RUV/AV-CO2.K	65	2-1/2"		24,2	#NV			
5.080.F.RUV/AV-CO2.K	80	3"		25,9	#NV			
5.100.F.RUV/AV-CO2.K	100	4"		32,7	#NV			

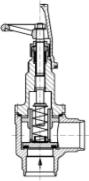
T6F.RUV/AV-CO2		Rückschlagventil, Eck	Anschluss		Kvs	Gewicht	Preis	
		Check Valve, Angle	Connection		Kvs	Weight	Price	
		Oberteil geflanscht Bolted bonnet	Artikel-Nr. / Article-No.	DN	Inch	[m³/h]	[kg]	[EUR]
			6.015.F.RUV/AV-CO2.K	15	1/2"	3,2	1,6	299,00 €
6.020.F.RUV/AV-CO2.K	20	3/4"	5,7	2,0	327,00 €			
6.025.F.RUV/AV-CO2.K	25	1"	8,9	3,4	348,00 €			
6.032.F.RUV/AV-CO2.K	32	1-1/4"	14,5	3,7	357,00 €			
6.040.F.RUV/AV-CO2.K	40	1-1/2"	22,7	4,6	372,00 €			
6.050.F.RUV/AV-CO2.K	50	2"	35,4	5,7	616,00 €			
6.065.F.RUV/AV-CO2.K	65	2-1/2"	59,8	18,0	926,00 €			
6.080.F.RUV/AV-CO2.K	80	3"	90,7	18,4	1.105,00 €			
6.100.F.RUV/AV-CO2.K	100	4"	141,7	23,7	1.424,00 €			

Absperrventile, SW Shut-Off Valves, SW

Standard: handbetätigt, aus Stahl, mit Muffen-Schweißenden nach ANSI, Kappe, PN25
Standard: manual actuated, made of steel, with socket weld ends according ANSI, cap, PN25

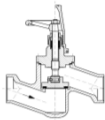
T51F		Absperrventil, Durchgang	Anschluss		Kvs	Gewicht	Preis
		Shut Off Valve, Globe	Connection		Kvs	Weight	Price
 Oberteil geflanscht Bolted bonnet		Artikel-Nr. / Article-No.	DN	Inch	[m³/h]	[kg]	[EUR]
		51.015.F.K	15	1/2"	3,1	1,2	153,00 €
		51.020.F.K	20	3/4"	6,1	1,5	164,00 €
		51.025.F.K	25	1"	10,0	2,5	198,00 €
		51.032.F.K	32	1-1/4"	15,0	2,7	216,00 €
		51.040.F.K	40	1-1/2"	23,3	4,3	254,00 €
51.050.F.K	50	2"	38,1	5,5	337,00 €		

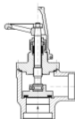
T61F		Absperrventil, Eck	Anschluss		Kvs	Gewicht	Preis
		Shut Off Valve, Angle	Connection		Kvs	Weight	Price
 Oberteil geflanscht Bolted bonnet		Artikel-Nr. / Article-No.	DN	Inch	[m³/h]	[kg]	[EUR]
		61.015.F.K	15	1/2"	3,6	1,4	144,00 €
		61.020.F.K	20	3/4"	8,0	1,6	156,00 €
		61.025.F.K	25	1"	15,6	2,8	189,00 €
		61.032.F.K	32	1-1/4"	28,4	3,1	214,00 €
		61.040.F.K	40	1-1/2"	28,5	3,8	243,00 €
61.050.F.K	50	2"	53,7	5,2	264,00 €		

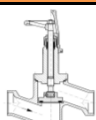
T51F.L		Absperrventil, Durchgang	Anschluss		Kvs	Gewicht	Preis
		Shut Off Valve, Globe	Connection		Kvs	Weight	Price
 Verlängertes Oberteil Extended bonnet		Artikel-Nr. / Article-No.	DN	Inch	[m³/h]	[kg]	[EUR]
		51.015.F.L.K	15	1/2"	3,1	1,6	170,00 €
		51.020.F.L.K	20	3/4"	6,1	1,8	178,00 €
		51.025.F.L.K	25	1"	10,0	3,0	227,00 €
		51.032.F.L.K	32	1-1/4"	15,0	3,1	242,00 €
		51.040.F.L.K	40	1-1/2"	23,3	4,8	273,00 €
51.050.F.L.K	50	2"	38,1	6,1	356,00 €		

T61F.L		Absperrventil, Eck	Connection		Kvs	Weight	Price
		Shut Off Valve, Angle	Connection		Kvs	Weight	Price
 Verlängertes Oberteil Extended bonnet		Artikel-Nr. / Article-No.	DN	Inch	[m³/h]	[kg]	[EUR]
		61.015.F.L.K	15	1/2"	3,6	1,8	160,00 €
		61.020.F.L.K	20	3/4"	8,0	2,0	173,00 €
		61.025.F.L.K	25	1"	15,6	3,4	219,00 €
		61.032.F.L.K	32	1-1/4"	28,4	3,5	241,00 €
		61.040.F.L.K	40	1-1/2"	28,5	4,4	260,00 €
61.050.F.L.K	50	2"	53,7	5,8	284,00 €		

Absperrventile CO₂, SW Shut-Off Valves CO₂, SW

Standard: handbetätigt, aus Stahl, mit Muffen-Schweißenden nach ANSI, Kappe, PN40,
Standard: manual actuated, made of steel, with socket weld ends according ANSI, cap, PN40

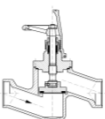
T51F-CO ₂		absperrentil, Durchgang	Anschluss		Kvs	Gewicht	Preis
		Shut Off Valve, Globe	Connection		Kvs	Weight	Price
 Oberteil geflanscht Für trockenes CO ₂ Bolted bonnet For dry CO ₂		Artikel-Nr. / Article-No.	DN	Inch	[m³/h]	[kg]	[EUR]
		51.015.F-CO ₂ .K	15	1/2"	3,1	1,2	164,00 €
		51.020.F-CO ₂ .K	20	3/4"	6,1	1,5	175,00 €
		51.025.F-CO ₂ .K	25	1"	10,0	2,5	218,00 €
		51.032.F-CO ₂ .K	32	1-1/4"	15,0	2,7	232,00 €
		51.040.F-CO ₂ .K	40	1-1/2"	23,3	4,3	278,00 €
51.050.F-CO ₂ .K	50	2"	38,1	5,5	364,00 €		

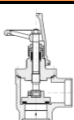
T61F-CO ₂		Absperrventil, Eck	Anschluss		Kvs	Gewicht	Preis
		Shut Off Valve, Angle	Connection		Kvs	Weight	Price
 Oberteil geflanscht Für trockenes CO ₂ Bolted bonnet For dry CO ₂		Artikel-Nr. / Article-No.	DN	Inch	[m³/h]	[kg]	[EUR]
		61.015.F-CO ₂ .K	15	1/2"	3,6	1,4	153,00 €
		61.020.F-CO ₂ .K	20	3/4"	8,0	1,6	167,00 €
		61.025.F-CO ₂ .K	25	1"	15,6	2,8	207,00 €
		61.032.F-CO ₂ .K	32	1-1/4"	28,4	3,1	231,00 €
		61.040.F-CO ₂ .K	40	1-1/2"	28,5	3,8	266,00 €
61.050.F-CO ₂ .K	50	2"	53,7	5,2	291,00 €		

Absperrventile CO², SW

Shut-Off Valves CO², SW

Standard: handbetätigt, aus Stahl, mit Muffen-Schweißenden nach ANSI, Kappe, PN40,
Standard: manual actuated, made of steel, with socket weld ends according ANSI, cap, PN40

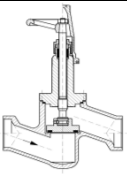
T51F.L-CO2		Absperrventil, Durchgang	Anschluss		Kvs	Gewicht	Preis
		Shut Off Valve, Globe	Connection		Kvs	Weight	Price
 Oberteil geflanscht Für trockenes CO2 Verlängertes Oberteil Bolted bonnet For dry CO2 Extended bonnet		Artikel-Nr. / Article-No.	DN	Inch	[m ³ /h]	[kg]	[EUR]
		51.015.F.L-CO2.K	15	1/2"	3,1	1,6	185,00 €
51.020.F.L-CO2.K	20	3/4"	6,1	1,8	198,00 €		
51.025.F.L-CO2.K	25	1"	10,0	3,0	250,00 €		
51.032.F.L-CO2.K	32	1-1/4"	15,0	3,1	267,00 €		
51.040.F.L-CO2.K	40	1-1/2"	23,3	4,8	309,00 €		
51.050.F.L-CO2.K	50	2"	38,1	6,1	397,00 €		

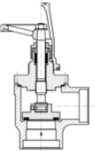
T61F.L-CO2		Absperrventil, Eck	Anschluss		Kvs	Gewicht	Preis
		Shut Off Valve, Angle	Connection		Kvs	Weight	Price
 Oberteil geflanscht Für trockenes CO2 Verlängertes Oberteil Bolted bonnet For dry CO2 Extended bonnet		Artikel-Nr. / Article-No.	DN	Inch	[m ³ /h]	[kg]	[EUR]
		61.015.F.L-CO2.K	15	1/2"	3,6	1,8	182,00 €
61.020.F.L-CO2.K	20	3/4"	8,0	2,0	190,00 €		
61.025.F.L-CO2.K	25	1"	15,6	3,4	242,00 €		
61.032.F.L-CO2.K	32	1-1/4"	28,4	3,5	266,00 €		
61.040.F.L-CO2.K	40	1-1/2"	28,5	4,4	299,00 €		
61.050.F.L-CO2.K	50	2"	53,7	5,8	323,00 €		

Regelventile, SW

Regulating Valve, SW

Standard: handbetätigt, aus Stahl, mit Muffen-Schweißenden nach ANSI, Kappe, PN25
Standard: manual actuated, made of steel, with socket weld ends according ANSI, cap, PN25

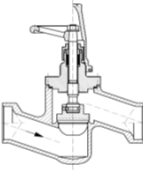
T51F-R		Regelventil, Durchgang	Anschluss		Kvs	Gewicht	Preis
		Regulating Valve, Globe	Connection		Kvs	Weight	Price
 Oberteil geflanscht Bolted bonnet		Artikel-Nr. / Article-No.	DN	Inch	[m ³ /h]	[kg]	[EUR]
		51.015.F-R.K	15	1/2"	3,8	1,2	159,00 €
51.020.F-R.K	20	3/4"	6,1	1,5	168,00 €		
51.025.F-R.K	25	1"	8,8	2,5	202,00 €		
51.032.F-R.K	32	1-1/4"	12,7	2,7	221,00 €		
51.040.F-R.K	40	1-1/2"	24,0	4,3	263,00 €		
51.050.F-R.K	50	2"	34,8	5,5	352,00 €		

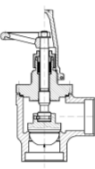
T61F-R		Regelventil, Eck	Anschluss		Kvs	Gewicht	Preis
		Regulating Valve, Angle	Connection		Kvs	Weight	Price
 Oberteil geflanscht Bolted bonnet		Artikel-Nr. / Article-No.	DN	Inch	[m ³ /h]	[kg]	[EUR]
		61.015.F-R.K	15	1/2"	5,3	1,4	149,00 €
61.020.F-R.K	20	3/4"	8,9	1,6	162,00 €		
61.025.F-R.K	25	1"	14,0	2,8	193,00 €		
61.032.F-R.K	32	1-1/4"	23,8	3,1	219,00 €		
61.040.F-R.K	40	1-1/2"	37,8	3,8	254,00 €		
61.050.F-R.K	50	2"	55,4	5,2	281,00 €		

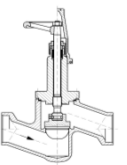
T51F.L-R		Regelventil, Durchgang	Anschluss		Kvs	Gewicht	Preis
		Regulating Valve, Globe	Connection		Kvs	Weight	Price
 Verlängertes Oberteil Extended bonnet		Artikel-Nr. / Article-No.	DN	Inch	[m ³ /h]	[kg]	[EUR]
		51.015.F.L-R.K	15	1/2"	3,8	1,6	175,00 €
51.020.F.L-R.K	20	3/4"	6,1	1,8	183,00 €		
51.025.F.L-R.K	25	1"	8,8	3,0	232,00 €		
51.032.F.L-R.K	32	1-1/4"	12,7	3,1	247,00 €		
51.040.F.L-R.K	40	1-1/2"	24,0	4,8	283,00 €		
51.050.F.L-R.K	50	2"	34,8	6,1	370,00 €		

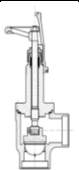
T61F.L-R		Regelventil, Eck	Anschluss		Kvs	Gewicht	Preis
		Regulating Valve, Angle	Connection		Kvs	Weight	Price
 Verlängertes Oberteil Extended bonnet		Artikel-Nr. / Article-No.	DN	Inch	[m ³ /h]	[kg]	[EUR]
		61.015.F.L-R.K	15	1/2"	5,3	1,8	166,00 €
61.020.F.L-R.K	20	3/4"	8,9	2,0	177,00 €		
61.025.F.L-R.K	25	1"	14,0	3,4	224,00 €		
61.032.F.L-R.K	32	1-1/4"	23,8	3,5	246,00 €		
61.040.F.L-R.K	40	1-1/2"	37,8	4,4	273,00 €		
61.050.F.L-R.K	50	2"	55,4	5,8	300,00 €		

Regelventile CO₂, SW Regulating Valves CO₂, SW

handbetätigt, aus Stahl, mit Muffen-Schweißenden nach ANSI, Kappe, PN40,
manual actuated, made of steel, with socket weld ends according ANSI, cap, PN40

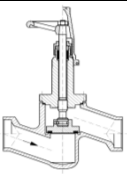
T51F-CO2-R		Regelventil, Durchgang	Anschluss		Kvs	Gewicht	Preis
		Regulating Valve, Globe	Connection		Kvs	Weight	Price
		Artikel-Nr. / Article-No.	DN	Inch	[m ³ /h]	[kg]	[EUR]
		Oberteil geflanscht Für trockenes CO ₂ Bolted bonnet For dry CO ₂		51.015.F-CO2-R.K	15	1/2"	3,8
51.020.F-CO2-R.K	20			3/4"	6,1	2,0	179,00 €
51.025.F-CO2-R.K	25			1"	8,8	3,5	223,00 €
51.032.F-CO2-R.K	32			1-1/4"	12,7	4,0	238,00 €
51.040.F-CO2-R.K	40			1-1/2"	24,0	5,5	289,00 €
51.050.F-CO2-R.K	50			2"	34,8	7,2	380,00 €

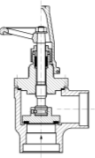
T61F-CO2-R		Regelventil, Eck	Anschluss		Kvs	Gewicht	Preis	
		Regulating Valve, Angle	Connection		Kvs	Weight	Price	
		Artikel-Nr. / Article-No.	[mm]	DN	Inch	[m ³ /h]	[kg]	[EUR]
		Oberteil geflanscht Für trockenes CO ₂ Bolted bonnet For dry CO ₂		61.015.F-CO2-R.K		15	1/2"	5,3
61.020.F-CO2-R.K				20	3/4"	8,9	1,6	174,00 €
61.025.F-CO2-R.K				25	1"	14,0	2,8	214,00 €
61.032.F-CO2-R.K				32	1-1/4"	23,8	3,1	235,00 €
61.040.F-CO2-R.K				40	1-1/2"	37,8	3,8	278,00 €
61.050.F-CO2-R.K				50	2"	55,4	5,2	306,00 €

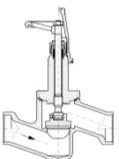
T51F.L-CO2-R		Regelventil, Durchgang	Anschluss		Kvs	Gewicht	Preis
		Regulating Valve, Globe	Connection		Kvs	Weight	Price
		Artikel-Nr. / Article-No.	DN	Inch	[m ³ /h]	[kg]	[EUR]
		Oberteil geflanscht Für trockenes CO ₂ Verlängertes Oberteil Bolted bonnet For dry CO ₂ Extended bonnet		51.015.F.L-CO2-R.K	15	1/2"	3,8
51.020.F.L-CO2-R.K	20			3/4"	6,1	1,8	202,00 €
51.025.F.L-CO2-R.K	25			1"	8,8	3,0	257,00 €
51.032.F.L-CO2-R.K	32			1-1/4"	12,7	3,1	273,00 €
51.040.F.L-CO2-R.K	40			1-1/2"	24,0	4,8	321,00 €
51.050.F.L-CO2-R.K	50			2"	34,8	6,1	411,00 €

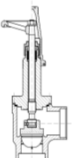
T61F.L-CO2-R		Regelventil, Eck	Anschluss		Kvs	Gewicht	Preis
		Regulating Valve, Angle	Connection		Kvs	Weight	Price
		Artikel-Nr. / Article-No.	DN	Inch	[m ³ /h]	[kg]	[EUR]
		Oberteil geflanscht Für trockenes CO ₂ Verlängertes Oberteil Bolted bonnet For dry CO ₂ Extended bonnet		61.015.F.L-CO2-R.K	15	1/2"	5,3
61.020.F.L-CO2-R.K	20			3/4"	8,9	2,0	194,00 €
61.025.F.L-CO2-R.K	25			1"	14,0	3,4	247,00 €
61.032.F.L-CO2-R.K	32			1-1/4"	23,8	3,5	272,00 €
61.040.F.L-CO2-R.K	40			1-1/2"	37,8	4,4	309,00 €
61.050.F.L-CO2-R.K	50			2"	55,4	5,8	339,00 €

Schmutzsammler, SW Strainer, SW

aus Stahl, PN25, mit Muffen-Schweißenden nach ANSI, Maschenweite 0,5mm, (auch für CO₂ geeignet) Alternative: Maschenw. 0,1 oder 0,25mm
made of steel, PN25, with socket weld ends according to ANSI, mesh size 0,5mm, (also suitable for CO₂) Alternative: mesh size 0,1 or 0,25mm

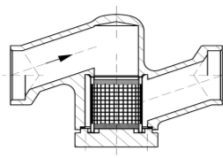
T51F-SS		Schmutzsammler, Durchg.	Masche	Anschluss		Kvs	Gewicht	Preis
		Strainer, Globe	Mesh	Connection		Kvs	Weight	Price
		Artikel-Nr. / Article-No.	[mm]	DN	Inch	[m ³ /h]	[kg]	[EUR]
		Oberteil geflanscht Bolted bonnet Bestellbeispiel / how to order: 5.040.F-SS.Y Y=5 0,5mm Y=1 0,1mm Y=25 0,25mm		51.015.F-SS.5	0,5	15	1/2"	5,8
51.020.F-SS.5	0,5			20	3/4"	7,3	1,3	151,00 €
51.025.F-SS.5	0,5			25	1"	11,8	2,3	174,00 €
51.032.F-SS.5	0,5			32	1-1/4"	15,5	2,5	175,00 €
51.040.F-SS.5	0,5			40	1-1/2"	24,9	3,8	194,00 €
51.050.F-SS.5	0,5			50	2"	33,4	5,1	267,00 €

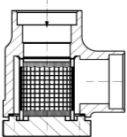
T61F-SS		Schmutzsammler, Eck	Masche	Anschluss		Kvs	Gewicht	Preis
		Strainer, Angle	Mesh	Connection		Kvs	Weight	Price
		Artikel-Nr. / Article-No.	[mm]	DN	Inch	[m ³ /h]	[kg]	[EUR]
		Oberteil geflanscht Bolted bonnet Bestellbeispiel / how to order: 5.040.F-SS.Y Y=5 0,5mm Y=1 0,1mm Y=25 0,25mm		61.015.F-SS.5	0,5	15	1/2"	5,8
61.020.F-SS.5	0,5			20	3/4"	7,3	1,0	144,00 €
61.025.F-SS.5	0,5			25	1"	11,8	1,9	165,00 €
61.032.F-SS.5	0,5			32	1-1/4"	15,5	1,8	174,00 €
61.040.F-SS.5	0,5			40	1-1/2"	24,9	2,6	184,00 €
61.050.F-SS.5	0,5			50	2"	33,4	3,7	195,00 €

Rückschlagventile, SW Check Valve, SW

TF: Für die Flüssigkeitsleitung und Heissgas-Abtauung
TF: For liquid line and hotgas-defrosting
Standard: aus Stahl, PN25, mit Muffen-Schweißenden nach ANSI
Standard: made of steel, PN25, with socket weld ends according to ANSI
Auslegung mit V.S.P. Valve Selection Program erforderlich
Selection by V.S.P. Valve Selection Program required

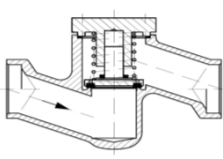
T51F-RUV/TF		Rückschlagventil, Durchg.	Anschluss		Kvs	Gewicht	Preis
		Check Valve, Globe	Connection		Kvs	Weight	Price
 Oberteil geflanscht Bolted bonnet		Artikel-Nr. / Article-No.	DN	Inch	[m³/h]	[kg]	[EUR]
		51.015.F-RUV/TF	15	1/2"	4,0	1,2	141,00 €
51.020.F-RUV/TF	20	3/4"	7,0	1,5	149,00 €		
51.025.F-RUV/TF	25	1"	13,0	2,5	182,00 €		
51.032.F-RUV/TF	32	1-1/4"	13,0	2,7	193,00 €		
51.040.F-RUV/TF	40	1-1/2"	23,0	4,3	231,00 €		
51.050.F-RUV/TF	50	2"	31,0	5,5	313,00 €		

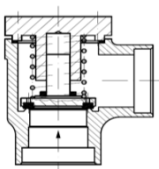
T61F-RUV/TF		Rückschlagventil, Eck	Anschluss		Kvs	Gewicht	Preis
		Check Valve, Angle	Connection		Kvs	Weight	Price
 Oberteil geflanscht Bolted bonnet		Artikel-Nr. / Article-No.	DN	Inch	[m³/h]	[kg]	[EUR]
		61.015.F-RUV/TF	15	1/2"	5,0	1,1	130,00 €
61.020.F-RUV/TF	20	3/4"	7,0	1,2	143,00 €		
61.025.F-RUV/TF	25	1"	14,0	2,3	174,00 €		
61.032.F-RUV/TF	32	1-1/4"	21,0	2,0	192,00 €		
61.040.F-RUV/TF	40	1-1/2"	23,0	3,1	222,00 €		
61.050.F-RUV/TF	50	2"	53,0	4,1	243,00 €		

Rückschlagventile, SW Check Valve, SW

TG: Nur für Verdichterdruckleitung und Sauggasleitung
TG: Only for compressor discharge line and suction line
aus Stahl, PN25, mit Muffen-Schweißenden nach ANSI
made of steel, PN25, with socket weld ends according to ANSI
Auslegung mit V.S.P. Valve Selection Program erforderlich
Selection by V.S.P. Valve Selection Program required

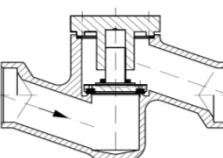
T51F-RUV/TG		Rückschlagventil, Durchg.	Anschluss		Kvs	Gewicht	Preis
		Check Valve, Globe	Connection		Kvs	Weight	Price
 Oberteil geflanscht Bolted bonnet		Artikel-Nr. / Article-No.	DN	Inch	[m³/h]	[kg]	[EUR]
		51.015.F-RUV/TG	15	1/2"	4,0	1,2	141,00 €
51.020.F-RUV/TG	20	3/4"	7,0	1,5	149,00 €		
51.025.F-RUV/TG	25	1"	13,0	2,5	182,00 €		
51.032.F-RUV/TG	32	1-1/4"	13,0	2,7	193,00 €		
51.040.F-RUV/TG	40	1-1/2"	23,0	4,3	231,00 €		
51.050.F-RUV/TG	50	2"	31,0	5,5	313,00 €		

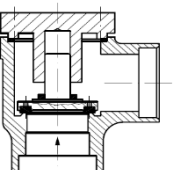
T61F-RUV/TG		Rückschlagventil, Eck	Anschluss		Kvs	Gewicht	Preis
		Check Valve, Angle	Connection		Kvs	Weight	Price
 Oberteil geflanscht Bolted bonnet		Artikel-Nr. / Article-No.	DN	Inch	[m³/h]	[kg]	[EUR]
		61.015.F-RUV/TG	15	1/2"	5,0	1,1	130,00 €
61.020.F-RUV/TG	20	3/4"	7,0	1,2	143,00 €		
61.025.F-RUV/TG	25	1"	14,0	2,3	174,00 €		
61.032.F-RUV/TG	32	1-1/4"	21,0	2,0	192,00 €		
61.040.F-RUV/TG	40	1-1/2"	23,0	3,1	222,00 €		
			53,0				

Absperrventile, SW/FPT Shut-Off Valves, SW/FPT

handbetätigt, aus Stahl, Eintritt: Muffen-Schweißenden nach ANSI, Austritt: FPT-Innengewinde, Kappe, PN25
manual actuated, made of steel, inlet: socket weld ends according ANSI, outlet: FPT male thread, cap, PN25

T51F.SW/FPT		Absperrventil, Durchgang	Anschluss		Kvs	Gewicht	Preis
		Shut Off Valve, Globe	Connection		Kvs	Weight	Price
Artikel-Nr. / Article-No.		DN	Inch	[m³/h]	[kg]	[EUR]	
Oberteil geflanscht Bolted bonnet	51.015.F.SW-FPT.K	15	1/2"	3,1	1,2	157,00 €	
	51.020.F.SW-FPT.K	20	3/4"	6,1	1,5	167,00 €	
	51.025.F.SW-FPT.K	25	1"	10,0	2,5	201,00 €	
	51.032.F.SW-FPT.K	32	1-1/4"	15,0	3,8	#NV	

T61F.SW/FPT		Absperrventil, Eck	Anschluss		Kvs	Gewicht	Preis
		Shut Off Valve, Angle	Connection		Kvs	Weight	Price
Artikel-Nr. / Article-No.		DN	Inch	[m³/h]	[kg]	[EUR]	
Oberteil geflanscht Bolted bonnet	61.015.F.SW-FPT.K	15	1/2"	3,6	1,4	153,00 €	
	61.020.F.SW-FPT.K	20	3/4"	8,0	1,6	160,00 €	
	61.025.F.SW-FPT.K	25	1"	15,6	2,8	- €	
	61.032.F.SW-FPT.K	32	1-1/4"	28,4	3,1	#NV	

T51F.L.SW/FPT		Absperrventil, Durchgang	Anschluss		Kvs	Gewicht	Preis
		Shut Off Valve, Globe	Connection		Kvs	Weight	Price
Artikel-Nr. / Article-No.		DN	Inch	[m³/h]	[kg]	[EUR]	
Verlängertes Oberteil Extended bonnet	51.015.F.L.SW-FPT.K	15	1/2"	3,1	1,6	174,00 €	
	51.020.F.L.SW-FPT.K	20	3/4"	6,1	1,8	182,00 €	
	51.025.F.L.SW-FPT.K	25	1"	10,0	3,0	231,00 €	
	51.032.F.L.SW-FPT.K	32	1-1/4"	15,0	4,7	170,00 €	

T61F.L.SW/FPT		Absperrventil, Eck	Connection		Kvs	Weight	Price
		Shut Off Valve, Angle	Connection		Kvs	Weight	Price
Artikel-Nr. / Article-No.		DN	Inch	[m³/h]	[kg]	[EUR]	
Verlängertes Oberteil Extended bonnet	61.015.F.L.SW-FPT.K	15	1/2"	3,6	1,8	170,00 €	
	61.020.F.L.SW-FPT.K	20	3/4"	8,0	2,0	176,00 €	
	61.025.F.L.SW-FPT.K	25	1"	15,6	2,8	- €	
	61.032.F.L.SW-FPT.K	32	1-1/4"	28,4	3,5	#NV	

Absperrventile CO₂, SW/FPT Shut-Off Valves CO₂, SW/FPT

handbetätigt, aus Stahl, Eintritt: Muffen-Schweißenden nach ANSI, Austritt: FPT-Innengewinde, Kappe, PN40
manual actuated, made of steel, inlet: socket weld ends according ANSI, outlet: FPT male thread, cap, PN40

T51F.SW/FPT-CO ₂		Absperrventil, Durchgang	Anschluss		Kvs	Gewicht	Preis
		Shut Off Valve, Globe	Connection		Kvs	Weight	Price
Artikel-Nr. / Article-No.		DN	Inch	[m³/h]	[kg]	[EUR]	
Oberteil geflanscht Bolted bonnet	51.015.F.SW-FPT-CO ₂ .K	15	1/2"	3,1	1,2	174,00 €	
	51.020.F.SW-FPT-CO ₂ .K	20	3/4"	6,1	1,5	183,00 €	
	51.025.F.SW-FPT-CO ₂ .K	25	1"	10,0	2,5	227,00 €	
	51.032.F.SW-FPT-CO ₂ .K	32	1-1/4"	15,0	3,8	#NV	

T51F.L.SW/FPT-CO ₂		Absperrventil, Durchgang	Anschluss		Kvs	Gewicht	Preis
		Shut Off Valve, Globe	Connection		Kvs	Weight	Price
Artikel-Nr. / Article-No.		DN	Inch	[m³/h]	[kg]	[EUR]	
Verlängertes Oberteil Extended bonnet	51.015.F.L.SW-FPT-CO ₂ .K	15	1/2"	3,6	1,6	190,00 €	
	51.020.F.L.SW-FPT-CO ₂ .K	20	3/4"	8,0	1,8	207,00 €	
	51.025.F.L.SW-FPT-CO ₂ .K	25	1"	15,6	3,0	260,00 €	
	51.032.F.L.SW-FPT-CO ₂ .K	32	1-1/4"	28,4	4,7	#NV	

Regelventile, SW/FPT Regulating Valve, SW/FPT

handbetätigt, aus Stahl, Eintritt: Muffen-Schweißenden nach ANSI, Austritt: FPT-Innengewinde, Kappe, PN25
manual actuated, made of steel, inlet: socket weld ends according ANSI, outlet: FPT male thread, cap, PN25

T51F.SW/FPT-R		Regelventil, Durchgang	Anschluss		Kvs	Gewicht	Preis
		Regulating Valve, Globe	Connection		Kvs	Weight	Price
Oberteil geflanscht Bolted bonnet		Artikel-Nr. / Article-No.	DN	Inch	[m³/h]	[kg]	[EUR]
				51.015.F.SW-FPT-R.K	15	1/2"	3,8
		51.020.F.SW-FPT-R.K	20	3/4"	6,1	1,5	173,00 €
		51.025.F.SW-FPT-R.K	25	1"	8,8	2,5	208,00 €
		51.032.F.SW-FPT-R.K	32	1-1/4"	12,7	3,8	#NV

T61F.SW/FPT-R		Regelventil, Eck	Anschluss		Kvs	Gewicht	Preis
		Regulating Valve, Angle	Connection		Kvs	Weight	Price
Oberteil geflanscht Bolted bonnet		Artikel-Nr. / Article-No.	DN	Inch	[m³/h]	[kg]	[EUR]
				61.015.F.SW-FPT-R.K	15	1/2"	5,3
		61.020.F.SW-FPT-R.K	20	3/4"	8,9	1,6	166,00 €
		61.025.F.SW-FPT-R.K	25	1"	14,0	2,8	#NV
		61.032.F.SW-FPT-R.K	32	1-1/4"	23,8	3,1	#NV

T51F.L.SW/FPT-R		Regelventil, Durchgang	Anschluss		Kvs	Gewicht	Preis
		Regulating Valve, Globe	Connection		Kvs	Weight	Price
Verlängertes Oberteil Extended bonnet		Artikel-Nr. / Article-No.	DN	Inch	[m³/h]	[kg]	[EUR]
				51.015.F.L.SW-FPT-R.K	15	1/2"	3,8
		51.020.F.L.SW-FPT-R.K	20	3/4"	6,1	1,8	178,00 €
		51.025.F.L.SW-FPT-R.K	25	1"	8,8	3,0	235,00 €
		51.032.F.L.SW-FPT-R.K	32	1-1/4"	12,7	4,7	#NV

T61F.L.SW/FPT-R		Regelventil, Eck	Anschluss		Kvs	Gewicht	Preis
		Regulating Valve, Angle	Connection		Kvs	Weight	Price
Verlängertes Oberteil Extended bonnet		Artikel-Nr. / Article-No.	DN	Inch	[m³/h]	[kg]	[EUR]
				61.015.F.L.SW-FPT-R.K	15	1/2"	5,3
		61.020.F.L.SW-FPT-R.K	20	3/4"	8,9	2,0	181,00 €
		61.025.F.L.SW-FPT-R.K	25	1"	14,0	3,4	#NV
		61.032.F.L.SW-FPT-R.K	32	1-1/4"	23,8	3,5	#NV

Regelventile CO², SW/FPT Regulating Valves CO², SW/FPT

handbetätigt, aus Stahl, Eintritt: Muffen-Schweißenden nach ANSI, Austritt: FPT-Innengewinde, Kappe, PN40
manual actuated, made of steel, inlet: socket weld ends according ANSI, outlet: FPT male thread, cap, PN40

T51F.SW/FPT-CO2-R		Regelventil, Durchgang	Anschluss		Kvs	Gewicht	Preis
		Regulating Valve, Globe	Connection		Kvs	Weight	Price
Oberteil geflanscht Für trockenes CO2 Bolted bonnet For dry CO2		Artikel-Nr. / Article-No.	DN	Inch	[m³/h]	[kg]	[EUR]
				51.015.F.SW-FPT-CO2-R.K	15	1/2"	3,8
		51.020.F.SW-FPT-CO2-R.K	20	3/4"	6,1	2,0	183,00 €
		51.025.F.SW-FPT-CO2-R.K	25	1"	8,8	3,5	227,00 €
		51.032.F.SW-FPT-CO2-R.K	32	1-1/4"	12,7	3,8	#NV

T51F.L.SW/FPT-CO2-R		Regelventil, Durchgang	Anschluss		Kvs	Gewicht	Preis
		Regulating Valve, Globe	Connection		Kvs	Weight	Price
Oberteil geflanscht Für trockenes CO2 Verlängertes Oberteil Bolted bonnet		Artikel-Nr. / Article-No.	DN	Inch	[m³/h]	[kg]	[EUR]
				51.015.F.L.SW-FPT-CO2-R.K	15	1/2"	3,8
		51.020.F.L.SW-FPT-CO2-R.K	20	3/4"	6,1	1,8	207,00 €
		51.025.F.L.SW-FPT-CO2-R.K	25	1"	8,8	3,0	260,00 €
		51.032.F.L.SW-FPT-CO2-R.K	32	1-1/4"	12,7	4,7	#NV

Absperrventile, FPT Shut-Off Valves, FPT

handbetätigt, aus Stahl, FPT-Innengewinde, Kappe, PN25
manual actuated, made of steel, FPT male thread, cap, PN25

T52F		Absperrventil, Durchgang	Anschluss		Kvs	Gewicht	Preis
		Shut Off Valve, Globe	Connection	DN	Inch	Kvs	Weight
		Artikel-Nr. / Article-No.	DN	Inch	[m³/h]	[kg]	[EUR]
Oberteil geflanscht Bolted bonnet		52.015.F.K	15	1/2"	3,1	1,2	162,00 €
		52.020.F.K	20	3/4"	6,1	1,5	171,00 €
		52.025.F.K	25	1"	10,0	2,5	207,00 €
		52.032.F.K	32	1-1/4"	15,0	2,7	223,00 €

T62F		Absperrventil, Eck	Anschluss		Kvs	Gewicht	Preis
		Shut Off Valve, Angle	Connection	DN	Inch	Kvs	Weight
		Artikel-Nr. / Article-No.	DN	Inch	[m³/h]	[kg]	[EUR]
Oberteil geflanscht Bolted bonnet		62.015.F.K	15	1/2"	3,6	1,4	151,00 €
		62.020.F.K	20	3/4"	8,0	1,6	164,00 €
		62.025.F.K	25	1"	15,6	2,8	194,00 €
		62.032.F.K	32	1-1/4"	28,4	3,1	221,00 €

T52F.L		Absperrventil, Durchgang	Anschluss		Kvs	Gewicht	Preis
		Shut Off Valve, Globe	Connection	DN	Inch	Kvs	Weight
		Artikel-Nr. / Article-No.	DN	Inch	[m³/h]	[kg]	[EUR]
Verlängertes Oberteil Extended bonnet		52.015.F.L.K	15	1/2"	3,1	1,6	177,00 €
		52.020.F.L.K	20	3/4"	6,1	1,8	185,00 €
		52.025.F.L.K	25	1"	10,0	3,0	234,00 €
		52.032.F.L.K	32	1-1/4"	15,0	3,1	249,00 €

T62F.L		Absperrventil, Eck	Connection		Kvs	Weight	Price
		Shut Off Valve, Angle	Connection	DN	Inch	Kvs	Weight
		Artikel-Nr. / Article-No.	DN	Inch	[m³/h]	[kg]	[EUR]
Verlängertes Oberteil Extended bonnet		62.015.F.L.K	15	1/2"	3,6	1,8	167,00 €
		62.020.F.L.K	20	3/4"	8,0	2,0	178,00 €
		62.025.F.L.K	25	1"	15,6	3,4	225,00 €
		62.032.F.L.K	32	1-1/4"	28,4	3,5	247,00 €

Absperrventile CO², FPT Shut-Off Valves CO², FPT

handbetätigt, aus Stahl, FPT-Innengewinde, Kappe, PN40
manual actuated, made of steel, FPT male thread, cap, PN40

T52F-CO2		Absperrventil, Durchgang	Anschluss		Kvs	Gewicht	Preis
		Shut Off Valve, Globe	Connection	DN	Inch	Kvs	Weight
		Artikel-Nr. / Article-No.	DN	Inch	[m³/h]	[kg]	[EUR]
Oberteil geflanscht Bolted bonnet		52.015.F-CO2.K	15	1/2"	3,1	1,2	173,00 €
		52.020.F-CO2.K	20	3/4"	6,1	1,5	182,00 €
		52.025.F-CO2.K	25	1"	10,0	2,5	226,00 €
		52.032.F-CO2.K	32	1-1/4"	15,0	2,7	241,00 €

T52F.L-CO2		Absperrventil, Durchgang	Anschluss		Kvs	Gewicht	Preis
		Shut Off Valve, Globe	Connection	DN	Inch	Kvs	Weight
		Artikel-Nr. / Article-No.	DN	Inch	[m³/h]	[kg]	[EUR]
Verlängertes Oberteil Extended bonnet		52.015.F.L-CO2.K	15	1/2"	3,1	1,6	193,00 €
		52.020.F.L-CO2.K	20	3/4"	6,1	1,8	206,00 €
		52.025.F.L-CO2.K	25	1"	10,0	3,0	259,00 €
		52.032.F.L-CO2.K	32	1-1/4"	15,0	3,1	276,00 €

Regelventile, FPT Regulating Valve, FPT

handbetätigt, aus Stahl, Eintritt: FPT-Innengewinde, Kappe, PN25
manual actuated, made of steel, outlet: FPT male thread, cap, PN25

T52F-R		Regelventil, Durchgang	Anschluss		Kvs	Gewicht	Preis
		Regulating Valve, Globe	Connection		Kvs	Weight	Price
Oberteil geflanscht Bolted bonnet		Artikel-Nr. / Article-No.	DN	Inch	[m³/h]	[kg]	[EUR]
				52.015.F-R.K	15	1/2"	3,8
		52.020.F-R.K	20	3/4"	6,1	1,5	176,00 €
		52.025.F-R.K	25	1"	8,8	2,5	214,00 €
		52.032.F-R.K	32	1-1/4"	12,7	2,7	227,00 €

T62F-R		Regelventil, Eck	Anschluss		Kvs	Gewicht	Preis
		Regulating Valve, Angle	Connection		Kvs	Weight	Price
Oberteil geflanscht Bolted bonnet		Artikel-Nr. / Article-No.	DN	Inch	[m³/h]	[kg]	[EUR]
				62.015.F-R.K	15	1/2"	5,3
		62.020.F-R.K	20	3/4"	8,9	1,6	168,00 €
		62.025.F-R.K	25	1"	14,0	2,8	200,00 €
		62.032.F-R.K	32	1-1/4"	23,8	3,1	222,00 €

T52F.L-R		Regelventil, Durchgang	Anschluss		Kvs	Gewicht	Preis
		Regulating Valve, Globe	Connection		Kvs	Weight	Price
Verlängertes Oberteil Extended bonnet		Artikel-Nr. / Article-No.	DN	Inch	[m³/h]	[kg]	[EUR]
				52.015.F.L-R.K	15	1/2"	3,8
		52.020.F.L-R.K	20	3/4"	6,1	1,8	191,00 €
		52.025.F.L-R.K	25	1"	8,8	3,0	241,00 €
		52.032.F.L-R.K	32	1-1/4"	12,7	3,1	255,00 €

T62F.L-R		Regelventil, Eck	Anschluss		Kvs	Gewicht	Preis
		Regulating Valve, Angle	Connection		Kvs	Weight	Price
Verlängertes Oberteil Extended bonnet		Artikel-Nr. / Article-No.	DN	Inch	[m³/h]	[kg]	[EUR]
				62.015.F.L-R.K	15	1/2"	5,3
		62.020.F.L-R.K	20	3/4"	8,9	2,0	183,00 €
		62.025.F.L-R.K	25	1"	14,0	3,4	230,00 €
		62.032.F.L-R.K	32	1-1/4"	23,8	3,5	251,00 €

Regelventile CO², FPT Regulating Valves CO², FPT

handbetätigt, aus Stahl, Eintritt: Muffen-Schweißenden nach ANSI, Austritt: FPT-Innengewinde, Kappe, PN40
manual actuated, made of steel, inlet: socket weld ends according ANSI, outlet: FPT male thread, cap, PN40

T52F-CO2-R		Regelventil, Durchgang	Anschluss		Kvs	Gewicht	Preis
		Regulating Valve, Globe	Connection		Kvs	Weight	Price
Oberteil geflanscht Für trockenes CO2 Bolted bonnet For dry CO2		Artikel-Nr. / Article-No.	DN	Inch	[m³/h]	[kg]	[EUR]
				52.015.F-CO2-R.K	15	1/2"	3,8
		52.020.F-CO2-R.K	20	3/4"	6,1	2,0	187,00 €
		52.025.F-CO2-R.K	25	1"	8,8	3,5	231,00 €
		52.032.F-CO2-R.K	32	1-1/4"	12,7	4,0	246,00 €

T62F-CO2-R		Regelventil, Eck	Anschluss		Kvs	Gewicht	Preis
		Regulating Valve, Angle	Connection		Kvs	Weight	Price
Oberteil geflanscht Für trockenes CO2 Bolted bonnet For dry CO2		Artikel-Nr. / Article-No.	DN	Inch	[m³/h]	[kg]	[EUR]
				62.015.F-CO2-R.K	15	1/2"	5,3
		62.020.F-CO2-R.K	20	3/4"	8,9	1,6	179,00 €
		62.025.F-CO2-R.K	25	1"	14,0	2,8	221,00 €
		62.032.F-CO2-R.K	32	1-1/4"	23,8	3,1	243,00 €

T52F.L-CO2-R		Regelventil, Durchgang	Anschluss		Kvs	Gewicht	Preis
		Regulating Valve, Globe	Connection		Kvs	Weight	Price
Oberteil geflanscht Für trockenes CO2 Verlängertes Oberteil Bolted bonnet		Artikel-Nr. / Article-No.	DN	Inch	[m³/h]	[kg]	[EUR]
				52.015.F.L-CO2-R.K	15	1/2"	3,8
		52.020.F.L-CO2-R.K	20	3/4"	6,1	1,8	213,00 €
		52.025.F.L-CO2-R.K	25	1"	8,8	3,0	264,00 €
		52.032.F.L-CO2-R.K	32	1-1/4"	12,7	3,1	282,00 €

T62F.L-CO2-R		Regelventil, Eck	Anschluss		Kvs	Gewicht	Preis
		Regulating Valve, Angle	Connection		Kvs	Weight	Price
Oberteil geflanscht Für trockenes CO2 Verlängertes Oberteil Bolted bonnet		Artikel-Nr. / Article-No.	DN	Inch	[m³/h]	[kg]	[EUR]
				62.015.F.L-CO2-R.K	15	1/2"	5,3
		62.020.F.L-CO2-R.K	20	3/4"	8,9	2,0	202,00 €
		62.025.F.L-CO2-R.K	25	1"	14,0	3,4	255,00 €
		62.032.F.L-CO2-R.K	32	1-1/4"	23,8	3,5	279,00 €

Schmutzsammler, FPT Strainer, FPT

aus Stahl, PN25, mit FPT-Innengewinde, Maschenweite 0,5mm, (auch für CO2 geeignet)
made of steel, PN25, with FPT male thread, mesh size 0,5m, (also suitable for CO2)

Alternative: Maschenweite 0,1 oder 0,25mm
Alternative: mesh size 0,1 or 0,25mm

T52F-SS		Schmutzsammler, Durchg.	Masche	Anschluss		Kvs	Gewicht	Preis
		Strainer, Globe	Mesh	Connection		Kvs	Weight	Price
		Artikel-Nr. / Article-No.	[mm]	DN	Inch	[m³/h]	[kg]	[EUR]
	Oberteil geflanscht Bolted bonnet	52.015.F-SS.5	0,5	15	1/2"	5,8	1,0	145,00 €
		52.020.F-SS.5	0,5	20	3/4"	7,3	1,2	152,00 €
		52.025.F-SS.5	0,5	25	1"	11,8	2,0	184,00 €
		52.032.F-SS.5	0,5	32	1-1/4"	15,5	2,4	192,00 €

T62F-SS		Schmutzsammler, Eck	Masche	Anschluss		Kvs	Gewicht	Preis
		Strainer, Angle	Mesh	Connection		Kvs	Weight	Price
		Artikel-Nr. / Article-No.	[mm]	DN	Inch	[m³/h]	[kg]	[EUR]
	Oberteil geflanscht Bolted bonnet	62.015.F-SS.5	0,5	15	1/2"	5,8	0,9	134,00 €
		62.020.F-SS.5	0,5	20	3/4"	7,3	1,0	144,00 €
		62.025.F-SS.5	0,5	25	1"	11,8	1,9	175,00 €
		62.032.F-SS.5	0,5	32	1-1/4"	15,5	1,8	190,00 €

Rückschlagventile, FPT Check Valve, FPT

TF: Für die Flüssigkeitsleitung und Heissgas-Abtaugung
TF: For liquid line and hotgas-defrosting

aus Stahl, PN25, mit FPT-Innengewinde
made of steel, PN25, with FPT male thread

Auslegung mit V.S.P. Valve Selection Program erforderlich
Selection by V.S.P. Valve Selection Program required

T52F-RUV/TF		Rückschlagventil, Durchg.		Anschluss		Kvs	Gewicht	Preis
		Check Valve, Globe		Connection		Kvs	Weight	Price
		Artikel-Nr. / Article-No.		DN	Inch	[m³/h]	[kg]	[EUR]
	Oberteil geflanscht Bolted bonnet	52.015.F-RUV/TF		15	1/2"	4,0	1,2	148,00 €
		52.020.F-RUV/TF		20	3/4"	7,0	1,5	157,00 €
		52.025.F-RUV/TF		25	1"	13,0	2,5	190,00 €
		52.032.F-RUV/TF		32	1-1/4"	13,0	2,7	201,00 €

T62F-RUV/TF		Rückschlagventil, Eck		Anschluss		Kvs	Gewicht	Preis
		Check Valve, Angle		Connection		Kvs	Weight	Price
		Artikel-Nr. / Article-No.		DN	Inch	[m³/h]	[kg]	[EUR]
	Oberteil geflanscht Bolted bonnet	62.015.F-RUV/TF		15	1/2"	5,0	1,1	137,00 €
		62.020.F-RUV/TF		20	3/4"	7,0	1,2	149,00 €
		62.025.F-RUV/TF		25	1"	14,0	2,3	179,00 €
		62.032.F-RUV/TF		32	1-1/4"	21,0	2,0	199,00 €

Rückschlagventile, FPT Check Valve, FPT

TG: Nur für Verdichterdruckleitung und Sauggasleitung
TG: Only for compressor discharge line and suction line

aus Stahl, PN25, mit FPT-Innengewinde
made of steel, PN25, with FPT male thread

Auslegung mit V.S.P. Valve Selection Program erforderlich
Selection by V.S.P. Valve Selection Program required

T52F-RUV/TG		Rückschlagventil, Durchg.		Anschluss		Kvs	Gewicht	Preis
		Check Valve, Globe		Connection		Kvs	Weight	Price
		Artikel-Nr. / Article-No.		DN	Inch	[m³/h]	[kg]	[EUR]
	Oberteil geflanscht Bolted bonnet	52.015.F-RUV/TG		15	1/2"	4,0	1,2	148,00 €
		52.020.F-RUV/TG		20	3/4"	7,0	1,5	157,00 €
		52.025.F-RUV/TG		25	1"	13,0	2,5	190,00 €
		52.032.F-RUV/TG		32	1-1/4"	13,0	2,7	201,00 €

T62F-RUV/TG		Rückschlagventil, Eck		Anschluss		Kvs	Gewicht	Preis
		Check Valve, Angle		Connection		Kvs	Weight	Price
		Artikel-Nr. / Article-No.		DN	Inch	[m³/h]	[kg]	[EUR]
	Oberteil geflanscht Bolted bonnet	62.015.F-RUV/TG		15	1/2"	5,0	1,1	137,00 €
		62.020.F-RUV/TG		20	3/4"	7,0	1,2	149,00 €
		62.025.F-RUV/TG		25	1"	14,0	2,3	179,00 €
		62.032.F-RUV/TG		32	1-1/4"	21,0	2,0	199,00 €

Absperrventile, Flansch Shut-Off Valves, Flange

Flanschventil, handbetätigt, aus Stahl, PN25, mit Handhebel
Flanged Valve, manual actuated, made of steel, PN25, with lever

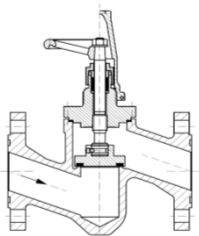
T2V		Absperrventil, Durchgang	Anschluss		Kvs	Gewicht	Preis
		Shut-Off Valve, Globe	Connection		Kvs	Weight	Price
 Flanschanschluß DIN2634 mit Nut EN1092-1 "D" With Flanged Connection DIN2634 with groove EN1092-1 "D"		Artikel-Nr. / Article-No.	DN	Inch	[m³/h]	[kg]	[EUR]
		2.015.V.K	15	1/2"	3,1	4,4	439,00 €
2.020.V.K	20	3/4"	6,1	4,9	451,00 €		
2.025.V.K	25	1"	10,0	6,2	462,00 €		
2.032.V.K	32	1-1/4"	15,0	8,3	601,00 €		
2.040.V.K	40	1-1/2"	23,3	9,9	751,00 €		
2.050.V.K	50	2"	38,1	13,7	772,00 €		
2.065.V.K	65	2-1/2"	69,6	24,0	1.052,00 €		
2.080.V.K	80	3"	100	31,0	1.123,00 €		
2.100.V.K	100	4"	159	43,0	1.641,00 €		
2.125.V.K	125	5"	242	79,0	2.426,00 €		
2.150.V.K	150	6"	406	107,0	3.297,00 €		
2.200.V.K	200	8"	628	183,0	4.663,00 €		

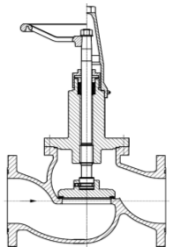
T2V.L		Absperrventil, Durchgang	Anschluss		Kvs	Gewicht	Preis
		Shut-Off Valve, Globe	Connection		Kvs	Weight	Price
 Verlängertes Oberteil Flanschanschluß DIN2634 mit Nut EN1092-1 "D" Extended Bonnet With Flanged Connection DIN2634 with groove EN1092-1 "D"		Artikel-Nr. / Article-No.	DN	Inch	[m³/h]	[kg]	[EUR]
		2.015.V.L.K	15	1/2"	3,1	4,9	469,00 €
2.020.V.L.K	20	3/4"	6,1	5,4	480,00 €		
2.025.V.L.K	25	1"	10,0	6,7	499,00 €		
2.032.V.L.K	32	1-1/4"	15,0	8,9	641,00 €		
2.040.V.L.K	40	1-1/2"	23,3	10,2	776,00 €		
2.050.V.L.K	50	2"	38,1	14,2	794,00 €		
2.065.V.L.K	65	2-1/2"	69,6	30,0	1.145,00 €		
2.080.V.L.K	80	3"	100	38,0	1.217,00 €		
2.100.V.L.K	100	4"	159	49,0	1.734,00 €		
2.125.V.L.K	125	5"	242	93,0	2.767,00 €		
2.150.V.L.K	150	6"	406	117,0	3.634,00 €		
2.200.V.L.K	200	8"	628	195,0	5.067,00 €		

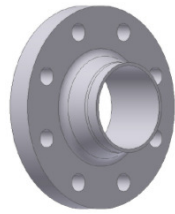
Gegenflansche / Counterflanges		Flansche (2 werden benötigt)	Anschluss		Gewicht	Preis
		Flange (you need 2 pcs.)	Connection		Weight	Price
 Stahl, PN25/40 Schweißenden DIN2634 mit Feder EN1092-1 "C" mit Schrauben, Muttern und Dichtungen Steel, PN25/40 ISO Butt Weld Ends DIN2634 with tongue EN1092-1 "C" with bolts, nuts and gasket		Artikel-Nr. / Article-No.	DN	Inch	[kg]	[EUR]
		FLADINF.015.SMD	15	1/2"	1,8	40,00 €
FLADINF.020.SMD	20	3/4"	2,5	42,00 €		
FLADINF.025.SMD	25	1"	2,9	43,00 €		
FLADINF.032.SMD	32	1-1/4"	4,1	61,00 €		
FLADINF.040.SMD	40	1-1/2"	4,8	67,00 €		
FLADINF.050.SMD	50	2"	6,1	74,00 €		
FLADINF.065.SMD	65	2-1/2"	9,0	101,00 €		
FLADINF.080.SMD	80	3"	11,0	111,00 €		
FLADINF.100.SMD	100	4"	16,5	167,00 €		
FLADINF.125.SMD	125	5"	23,0	295,00 €		
FLADINF.150.SMD	150	6"	28,5	324,00 €		
FLADINF.200.SMD	200	8"		490,00 €		

Absperrventile FABA, Flansch **Shut-Off Valves Bellows, Flange**

Flanschventile, handbetätigt, aus Stahl, PN25, mit Handhebel
Flanged Valve, manual actuated, made of steel, PN25, with lever

T2V.FA		Absperrventil, Durchgang	Anschluss		Kvs	Gewicht	Preis
		Shut-Off Valve, Globe	Connection		Kvs	Weight	Price
		Artikel-Nr. / Article-No.	DN	Inch	[m³/h]	[kg]	[EUR]
Spindelabdichtung: Faltenbalg Flanschanschluß DIN2634 mit Nut EN1092-1 "D" Stem Sealing: Bellows Seal With Flanged Connection DIN2634 with groove EN1092-1 "D"	2.015.V.FA.K	15	1/2"	3,1	5,2	863,00 €	
	2.020.V.FA.K	20	3/4"	6,1	5,6	899,00 €	
	2.025.V.FA.K	25	1"	10,0	6,7	938,00 €	
	2.032.V.FA.K	32	1-1/4"	15,0	9,2	1.104,00 €	
	2.040.V.FA.K	40	1-1/2"	23,3	11,0	1.281,00 €	
	2.050.V.FA.K	50	2"	38,1	13,7	1.322,00 €	
	2.065.V.FA.K	65	2-1/2"	69,6	31,0	2.189,00 €	
	2.080.V.FA.K	80	3"	100	35,0	2.309,00 €	
	2.100.V.FA.K	100	4"	159	46,0	2.953,00 €	
	2.125.V.FA.K	125	5"	242	80,0	5.936,00 €	
2.150.V.FA.K	150	6"	406	127,0	7.664,00 €		
2.200.V.FA.K	200	8"	628	207,0	10.598,00 €		

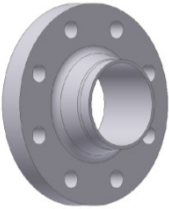
Gegenflansche / Counterflanges		Flansche (2 werden benötigt)	Anschluss		Gewicht	Preis
		Flange (you need 2 pcs.)	Connection		Weight	Price
		Artikel-Nr. / Article-No.	DN	Inch	[kg]	[EUR]
 Stahl, PN25/40 Schweißenden DIN2634 mit Feder EN1092-1 "C" mit Schrauben, Muttern und Dichtungen Steel, PN25/40 ISO Butt Weld Ends DIN2634 with tongue EN1092-1 "C" with bolts, nuts and gasket	FLADINF.015.SMD	15	1/2"	1,8	40,00 €	
	FLADINF.020.SMD	20	3/4"	2,5	42,00 €	
	FLADINF.025.SMD	25	1"	2,9	43,00 €	
	FLADINF.032.SMD	32	1-1/4"	4,1	61,00 €	
	FLADINF.040.SMD	40	1-1/2"	4,8	67,00 €	
	FLADINF.050.SMD	50	2"	6,1	74,00 €	
	FLADINF.065.SMD	65	2-1/2"	9,0	101,00 €	
	FLADINF.080.SMD	80	3"	11,0	111,00 €	
	FLADINF.100.SMD	100	4"	16,5	167,00 €	
	FLADINF.125.SMD	125	5"	23,0	295,00 €	
	FLADINF.150.SMD	150	6"	28,5	324,00 €	
	FLADINF.200.SMD	200	8"		490,00 €	

Absperrventile Flansch, CO² Shut-Off Valves Flange, CO²

Flanschventil, handbetätigt, aus Stahl, PN40, mit Handhebel
Flanged Valve, manual actuated, made of steel, PN40, with lever

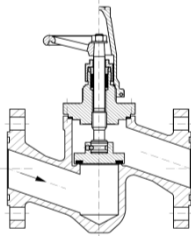
T2V-CO2		Absperrventil, Durchgang	Anschluss		Kvs	Gewicht	Preis
		Shut-Off Valve, Globe	Connection		Kvs	Weight	Price
Artikel-Nr. / Article-No.		DN	Inch	[m ³ /h]	[kg]	[EUR]	
 <p>Flanschanschluß DIN2634 mit Nut EN1092-1 "D"</p> <p>With Flanged Connection DIN2634 with groove EN1092-1 "D"</p>	2.015.V-CO2.K	15	1/2"	3,1	4,4	453,00 €	
	2.020.V-CO2.K	20	3/4"	6,1	4,9	466,00 €	
	2.025.V-CO2.K	25	1"	10,0	6,2	479,00 €	
	2.032.V-CO2.K	32	1-1/4"	15,0	8,3	618,00 €	
	2.040.V-CO2.K	40	1-1/2"	23,3	9,9	772,00 €	
	2.050.V-CO2.K	50	2"	38,1	13,7	792,00 €	
	2.065.V-CO2.K	65	2-1/2"	69,6	24,0	1.096,00 €	
	2.080.V-CO2.K	80	3"	100	31,0	1.167,00 €	
	2.100.V-CO2.K	100	4"	159	43,0	1.689,00 €	
	2.125.V-CO2.K	125	5"	242	79,0	2.495,00 €	
2.150.V-CO2.K	150	6"	406	107,0	3.398,00 €		
2.200.V-CO2.K	200	8"	628	183,0	4.766,00 €		

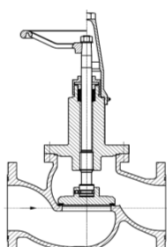
T2V.L-CO2		Absperrventil, Durchgang	Anschluss		Kvs	Gewicht	Preis
		Shut-Off Valve, Globe	Connection		Kvs	Weight	Price
Artikel-Nr. / Article-No.		DN	Inch	[m ³ /h]	[kg]	[EUR]	
 <p>Verlängertes Oberteil Flanschanschluß DIN2634 mit Nut EN1092-1 "D"</p> <p>Extended Bonnet With Flanged Connection DIN2634 with groove EN1092-1 "D"</p>	2.015.V.L-CO2.K	15	1/2"	3,1	4,9	488,00 €	
	2.020.V.L-CO2.K	20	3/4"	6,1	5,4	499,00 €	
	2.025.V.L-CO2.K	25	1"	10,0	6,7	513,00 €	
	2.032.V.L-CO2.K	32	1-1/4"	15,0	8,9	654,00 €	
	2.040.V.L-CO2.K	40	1-1/2"	23,3	10,2	806,00 €	
	2.050.V.L-CO2.K	50	2"	38,1	14,2	826,00 €	
	2.065.V.L-CO2.K	65	2-1/2"	69,6	30,0	1.203,00 €	
	2.080.V.L-CO2.K	80	3"	100	38,0	1.275,00 €	
	2.100.V.L-CO2.K	100	4"	159	49,0	1.796,00 €	
	2.125.V.L-CO2.K	125	5"	242	93,0	2.873,00 €	
	2.150.V.L-CO2.K	150	6"	406	117,0	3.775,00 €	
	2.200.V.L-CO2.K	200	8"	628	195,0	5.203,00 €	

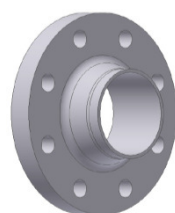
Gegenflansche / Counterflanges		Flansche (2 werden benötigt)	Anschluss		Gewicht	Preis
		Flange (you need 2 pcs.)	Connection		Weight	Price
Artikel-Nr. / Article-No.		DN	Inch	[kg]	[EUR]	
 <p>Stahl, PN25/40 Schweißenden DIN2634 mit Feder EN1092-1 "C" mit Schrauben, Muttern und Dichtungen</p> <p>Steel, PN25/40 ISO Butt Weld Ends DIN2634 with tongue EN1092-1 "C" with bolts, nuts and gasket</p>	FLADINF.015.SMD	15	1/2"	1,8	40,00 €	
	FLADINF.020.SMD	20	3/4"	2,5	42,00 €	
	FLADINF.025.SMD	25	1"	2,9	43,00 €	
	FLADINF.032.SMD	32	1-1/4"	4,1	61,00 €	
	FLADINF.040.SMD	40	1-1/2"	4,8	67,00 €	
	FLADINF.050.SMD	50	2"	6,1	74,00 €	
	FLADINF.065.SMD	65	2-1/2"	9,0	101,00 €	
	FLADINF.080.SMD	80	3"	11,0	111,00 €	
	FLADINF.100.SMD	100	4"	16,5	167,00 €	
	FLADINF.125.SMD	125	5"	23,0	295,00 €	
	FLADINF.150.SMD	150	6"	28,5	324,00 €	
FLADINF.200.SMD	200	8"		490,00 €		

Regelventile, Flansch

Regulating Valves, Flange

Flanschventil, handbetätigt, aus Stahl, PN25, mit Handhebel
Flanged Valve, manual actuated, made of steel, PN25, with lever

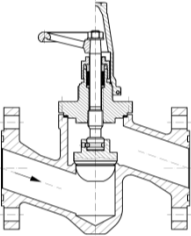
T2V-R		Regelventil, Durchgang	Anschluss		Kvs	Gewicht	Preis
		Regulating Valve, Globe	Connection		Kvs	Weight	Price
 Flanschanschluß DIN2634 mit Nut EN1092-1 "D" With Flanged Connection DIN2634 with groove EN1092-1 "D"		Artikel-Nr. / Article-No.	DN	Inch	[m³/h]	[kg]	[EUR]
		2.015.V-R.K	15	1/2"		4,5	447,00 €
2.020.V-R.K	20	3/4"		5,0	459,00 €		
2.025.V-R.K	25	1"		6,3	469,00 €		
2.032.V-R.K	32	1-1/4"		8,3	609,00 €		
2.040.V-R.K	40	1-1/2"		10,0	764,00 €		
2.050.V-R.K	50	2"		14,5	787,00 €		
2.065.V-R.K	65	2-1/2"		21,0	1.085,00 €		
2.080.V-R.K	80	3"		34,0	1.178,00 €		
2.100.V-R.K	100	4"		48,0	1.716,00 €		
2.125.V-R.K	125	5"		90,0	2.607,00 €		
2.150.V-R.K	150	6"		138,0	3.482,00 €		
2.200.V-R.K	200	8"		218,0	4.848,00 €		

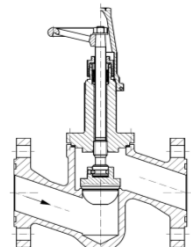
T2V.L-R		Regelventil, Durchgang	Anschluss		Kvs	Gewicht	Preis
		Regulating Valve, Globe	Connection		Kvs	Weight	Price
 Verlängertes Oberteil Flanschanschluß DIN2634 mit Nut EN1092-1 "D" Extended Bonnet With Flanged Connection DIN2634 with groove EN1092-1 "D"		Artikel-Nr. / Article-No.	DN	Inch	[m³/h]	[kg]	[EUR]
		2.015.V.L-R.K	15	1/2"		5,0	478,00 €
2.020.V.L-R.K	20	3/4"		5,5	487,00 €		
2.025.V.L-R.K	25	1"		6,8	507,00 €		
2.032.V.L-R.K	32	1-1/4"		8,7	648,00 €		
2.040.V.L-R.K	40	1-1/2"		10,5	787,00 €		
2.050.V.L-R.K	50	2"		15,1	812,00 €		
2.065.V.L-R.K	65	2-1/2"		24,0	1.179,00 €		
2.080.V.L-R.K	80	3"		39,0	1.270,00 €		
2.100.V.L-R.K	100	4"		53,0	1.811,00 €		
2.125.V.L-R.K	125	5"		94,0	2.947,00 €		
2.150.V.L-R.K	150	6"		153,0	3.819,00 €		
2.200.V.L-R.K	200	8"		224,0	5.252,00 €		

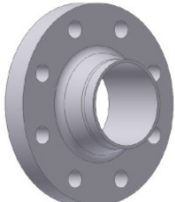
Gegenflansche / Counterflanges		Flansche (2 werden benötigt)	Anschluss		Gewicht	Preis
		Flange (you need 2 pcs.)	Connection		Weight	Price
 Stahl, PN25/40 Schweißenden DIN2634 mit Feder EN1092-1 "C" mit Schrauben, Muttern und Dichtungen Steel, PN25/40 ISO Butt Weld Ends DIN2634 with tongue EN1092-1 "C" with bolts, nuts and gasket		Artikel-Nr. / Article-No.	DN	Inch	[kg]	[EUR]
		FLADINF.015.SMD	15	1/2"		1,8
FLADINF.020.SMD	20	3/4"		2,5	42,00 €	
FLADINF.025.SMD	25	1"		2,9	43,00 €	
FLADINF.032.SMD	32	1-1/4"		4,1	61,00 €	
FLADINF.040.SMD	40	1-1/2"		4,8	67,00 €	
FLADINF.050.SMD	50	2"		6,1	74,00 €	
FLADINF.065.SMD	65	2-1/2"		9,0	101,00 €	
FLADINF.080.SMD	80	3"		11,0	111,00 €	
FLADINF.100.SMD	100	4"		16,5	167,00 €	
FLADINF.125.SMD	125	5"		23,0	295,00 €	
FLADINF.150.SMD	150	6"		28,5	324,00 €	
FLADINF.200.SMD	200	8"			490,00 €	

Regelventile FABA, Flansch Regulating Valves Bellows, Flange

Flanschventile, handbetätigt, aus Stahl, PN25, mit Handhebel
Flanged Valve, manual actuated, made of steel, PN25, with lever

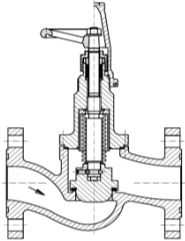
T2V.FA-R		Regelventil, Durchgang	Anschluss		Kvs	Gewicht	Preis
		Regulating Valve, Globe	Connection		Kvs	Weight	Price
 <p>Spindelabdichtung: Faltenbalg Flanschanschluß DIN2634 mit Nut EN1092-1 "D"</p> <p>Stem Sealing: Bellows Seal With Flanged Connection DIN2634 with groove EN1092-1 "D"</p>		Artikel-Nr. / Article-No.	DN	Inch	[m³/h]	[kg]	[EUR]
		2.015.V.FA-R.K	15	1/2"		5,2	868,00 €
2.020.V.FA-R.K	20	3/4"		5,6	906,00 €		
2.025.V.FA-R.K	25	1"		6,7	942,00 €		
2.032.V.FA-R.K	32	1-1/4"		9,2	1.110,00 €		
2.040.V.FA-R.K	40	1-1/2"		11,0	1.292,00 €		
2.050.V.FA-R.K	50	2"		13,7	1.341,00 €		
2.065.V.FA-R.K	65	2-1/2"		31,0	2.221,00 €		
2.080.V.FA-R.K	80	3"		35,0	2.363,00 €		
2.100.V.FA-R.K	100	4"		46,0	3.032,00 €		
2.125.V.FA-R.K	125	5"		80,0	6.115,00 €		
2.150.V.FA-R.K	150	6"		127,0	7.852,00 €		
2.200.V.FA-R.K	200	8"		207,0	10.781,00 €		

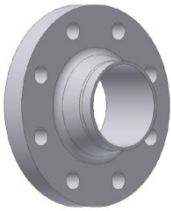
Gegenflansche / Counterflanges		Flansche (2 werden benötigt)	Anschluss		Gewicht	Preis
		Flange (you need 2 pcs.)	Connection		Weight	Price
 <p>Stahl, PN25/40 Schweißenden DIN2634 mit Feder EN1092-1 "C" mit Schrauben, Muttern und Dichtungen</p> <p>Steel, PN25/40 ISO Butt Weld Ends DIN2634 with tongue EN1092-1 "C" with bolts, nuts and gasket</p>		Artikel-Nr. / Article-No.	DN	Inch	[kg]	[EUR]
		FLADINF.015.SMD	15	1/2"		1,8
FLADINF.020.SMD	20	3/4"		2,5	42,00 €	
FLADINF.025.SMD	25	1"		2,9	43,00 €	
FLADINF.032.SMD	32	1-1/4"		4,1	61,00 €	
FLADINF.040.SMD	40	1-1/2"		4,8	67,00 €	
FLADINF.050.SMD	50	2"		6,1	74,00 €	
FLADINF.065.SMD	65	2-1/2"		9,0	101,00 €	
FLADINF.080.SMD	80	3"		11,0	111,00 €	
FLADINF.100.SMD	100	4"		16,5	167,00 €	
FLADINF.125.SMD	125	5"		23,0	295,00 €	
FLADINF.150.SMD	150	6"		28,5	324,00 €	
FLADINF.200.SMD	200	8"			490,00 €	

Dichtungen / Gaskets		Flanschdichtung	Inhalt	Anschluss		Größe	Preis
		Gasket (Flange)	Content	Connection		Size	Price
<p>Flanschdichtung für Nut EN1092-1 Form D</p> <p>Gasket (Flange) for groove EN1092-1 "D"</p>		Artikel-Nr. / Article-No.	[pcs.]	DN	Inch	[mm]	[EUR]
		DI.FLANUT.015	1	15	1/2"	39x29x2	7,00 €
DI.FLANUT.020	1	20	3/4"	50x36x2	7,00 €		
DI.FLANUT.025	1	25	1"	57x43x2	10,00 €		
DI.FLANUT.032	1	32	1-1/4"	65x51x2	10,00 €		
DI.FLANUT.040	1	40	1-1/2"	75x61x2	10,00 €		
DI.FLANUT.050	1	50	2"	87x73x2	13,00 €		
DI.FLANUT.065	1	65	2-1/2"	109x95x2	15,00 €		
DI.FLANUT.080	1	80	3"	20x106x2	18,00 €		
DI.FLANUT.100	1	100	4"	49x129x2	26,00 €		
DI.FLANUT.125	1	125	5"	75x155x2	32,00 €		
DI.FLANUT.150	1	150	6"	03x183x2	37,00 €		
DI.FLANUT.200	1	200	8"	59x239x2	59,00 €		
DI.FLANUT.250	1	250	10"	312x292x2	96,00 €		
DI.FLANUT.300	1	300	12"	363x343x2	105,00 €		

Schrauben, Muttern / Bolts, Nuts		Schrauben, Muttern	Inhalt	Anschluss		Größe	Preis
		Bolts, Nuts	Content	Connection		Size	Price
<p>Flanschschrauben und Muttern, metrisch, Edelstahl</p> <p>Bolts and nuts for flanges, metric, stainless steel</p>		Artikel-Nr. / Article-No.	[pcs.]	DN	Inch	[mm]	[EUR]
		SM.015.FLADIN	4	15-25	1/2" to 1"	M12x50	20,00 €
SM.032.FLADIN	4	32-50	1-1/4" to 2"	M16x55	39,00 €		
SM.065.FLADIN	8	65	2-1/2"	M16x60	75,00 €		
SM.080.FLADIN	8	80	3"	M16x65	75,00 €		
SM.100.FLADIN	8	100	4"	M20x70	162,00 €		
SM.125.FLADIN	8	125-150	5" to 6"	M24x80	373,00 €		
SM.200.FLADIN	12	200	8"	M24x90	597,00 €		
SM.250.FLADIN	12	250	10"	M27x90	832,00 €		
SM.300.FLADIN	16	300	12"	M27x100	1.164,00 €		

Regelventile Flansch, CO²

Regulating Valves Flange, CO²

Flanschventil, handbetätigt, aus Stahl, PN40, mit Handhebel
Flanged Valve, manual actuated, made of steel, PN40, with lever

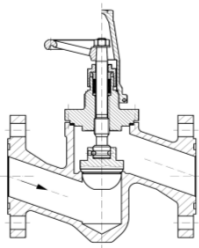
T2V-CO2-R		Regelventil, Durchgang	Anschluss		Kvs	Gewicht	Preis
		Regulating Valve, Globe	Connection		Kvs	Weight	Price
 Flanschanschluß DIN2634 mit Nut EN1092-1 "D" With Flanged Connection DIN2634 with groove EN1092-1 "D"		Artikel-Nr. / Article-No.	DN	Inch	[m ³ /h]	[kg]	[EUR]
		2.015.V-CO2-R.K	15	1/2"		4,5	462,00 €
2.020.V-CO2-R.K	20	3/4"		5,0	472,00 €		
2.025.V-CO2-R.K	25	1"		6,3	486,00 €		
2.032.V-CO2-R.K	32	1-1/4"		8,3	624,00 €		
2.040.V-CO2-R.K	40	1-1/2"		10,0	783,00 €		
2.050.V-CO2-R.K	50	2"		14,5	808,00 €		
2.065.V-CO2-R.K	65	2-1/2"		21,0	1.129,00 €		
2.080.V-CO2-R.K	80	3"		34,0	1.223,00 €		
2.100.V-CO2-R.K	100	4"		48,0	1.762,00 €		
2.125.V-CO2-R.K	125	5"		90,0	2.675,00 €		
2.150.V-CO2-R.K	150	6"		138,0	3.582,00 €		
2.200.V-CO2-R.K	200	8"		218,0	4.954,00 €		

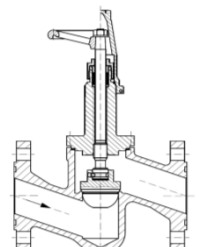
T2V.L-CO2-R		Regelventil, Durchgang	Anschluss		Kvs	Gewicht	Preis
		Regulating Valve, Globe	Connection		Kvs	Weight	Price
 Verlängertes Oberteil Flanschanschluß DIN2634 mit Nut EN1092-1 "D" Extended Bonnet With Flanged Connection DIN2634 with groove EN1092-1 "D"		Artikel-Nr. / Article-No.	DN	Inch	[m ³ /h]	[kg]	[EUR]
		2.015.V.L-CO2-R.K	15	1/2"		5,0	496,00 €
2.020.V.L-CO2-R.K	20	3/4"		5,5	507,00 €		
2.025.V.L-CO2-R.K	25	1"		6,8	519,00 €		
2.032.V.L-CO2-R.K	32	1-1/4"		8,7	661,00 €		
2.040.V.L-CO2-R.K	40	1-1/2"		10,5	819,00 €		
2.050.V.L-CO2-R.K	50	2"		15,1	843,00 €		
2.065.V.L-CO2-R.K	65	2-1/2"		24,0	1.237,00 €		
2.080.V.L-CO2-R.K	80	3"		39,0	1.329,00 €		
2.100.V.L-CO2-R.K	100	4"		53,0	1.869,00 €		
2.125.V.L-CO2-R.K	125	5"		94,0	3.052,00 €		
2.150.V.L-CO2-R.K	150	6"		153,0	3.959,00 €		
2.200.V.L-CO2-R.K	200	8"		224,0	5.389,00 €		

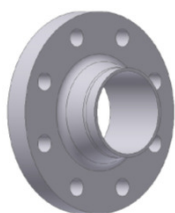
Gegenflansche / Counterflanges		Flansche (2 werden benötigt)	Anschluss		Gewicht	Preis
		Flange (you need 2 pcs.)	Connection		Weight	Price
 Stahl, PN25/40 Schweißenden DIN2634 mit Feder EN1092-1 "C" mit Schrauben, Muttern und Dichtungen Steel, PN25/40 ISO Butt Weld Ends DIN2634 with tongue EN1092-1 "C" with bolts, nuts and gasket		Artikel-Nr. / Article-No.	DN	Inch	[kg]	[EUR]
		FLADINF.015.SMD	15	1/2"		1,8
FLADINF.020.SMD	20	3/4"		2,5	42,00 €	
FLADINF.025.SMD	25	1"		2,9	43,00 €	
FLADINF.032.SMD	32	1-1/4"		4,1	61,00 €	
FLADINF.040.SMD	40	1-1/2"		4,8	67,00 €	
FLADINF.050.SMD	50	2"		6,1	74,00 €	
FLADINF.065.SMD	65	2-1/2"		9,0	101,00 €	
FLADINF.080.SMD	80	3"		11,0	111,00 €	
FLADINF.100.SMD	100	4"		16,5	167,00 €	
FLADINF.125.SMD	125	5"		23,0	295,00 €	
FLADINF.150.SMD	150	6"		28,5	324,00 €	
FLADINF.200.SMD	200	8"			490,00 €	

Schmutzsammler, Flansch **Strainer, Flange**

Flanschventil aus Stahl, PN25, Maschenweite 0,5mm, (auch für CO2 geeignet)
Flanged Valve made of steel, PN25, mesh size 0.5m, (also suitable for CO2)

Alternative: Maschenweite 0,1mm oder 0,25mm
Alternative: mesh size 0.1mm or 0.25mm

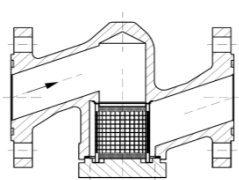
T2V-SS		Schmutzsammler, Durchg.	Masche	Anschluss		Kvs	Gewicht	Preis
		Strainer, Globe	Mesh	Connection		Kvs	Weight	Price
		Artikel-Nr. / Article-No.	[mm]	DN	Inch	[m³/h]	[kg]	[EUR]
 <p>Flanschanschluß DIN2634 mit Nut EN1092-1 "D" With Flanged Connection DIN2634 with groove EN1092-1 "D"</p>	2.015.V-SS.5	0,5	15	1/2"		3,6	377,00 €	
	2.020.V-SS.5	0,5	20	3/4"		4,3	386,00 €	
	2.025.V-SS.5	0,5	25	1"		5,3	407,00 €	
	2.032.V-SS.5	0,5	32	1-1/4"		6,8	492,00 €	
	2.040.V-SS.5	0,5	40	1-1/2"		10,2	624,00 €	
	2.050.V-SS.S	0,5	50	2"		12,5	632,00 €	

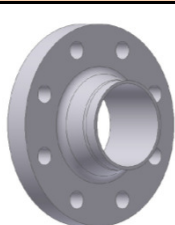
Gegenflansche / Counterflanges		Flansche (2 werden benötigt)		Anschluss		Gewicht	Preis
		Flange (you need 2 pcs.)		Connection		Weight	Price
		Artikel-Nr. / Article-No.	DN	Inch		[kg]	[EUR]
 <p>Stahl, PN25/40 Schweißenden DIN2634 mit Feder EN1092-1 "C" mit Schrauben, Muttern und Dichtungen Steel, PN25/40 ISO Butt Weld Ends DIN2634 with tongue EN1092-1 "C" with bolts, nuts and gasket</p>	FLADINF.015.SMD	15	1/2"		1,8	40,00 €	
	FLADINF.020.SMD	20	3/4"		2,5	42,00 €	
	FLADINF.025.SMD	25	1"		2,9	43,00 €	
	FLADINF.032.SMD	32	1-1/4"		4,1	61,00 €	
	FLADINF.040.SMD	40	1-1/2"		4,8	67,00 €	
	FLADINF.050.SMD	50	2"		6,1	74,00 €	

Rückschlagventile, Flansch **Check Valve, Flange**

TF: Für die Flüssigkeitsleitung und Heissgas-Abtaugung
TF: For liquid line and hotgas-defrosting

Flanschventil aus Stahl, PN25
Flanged Valve made of steel, PN25

Auslegung mit V.S.P. Valve Selection Program erforderlich
Selection by V.S.P. Valve Selection Program required

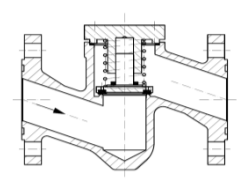
T2V-RUV/TF		Rückschlagventil, Durchg.	Anschluss		Kvs	Gewicht	Preis
		Check Valve, Globe	Connection		Kvs	Weight	Price
		Artikel-Nr. / Article-No.	DN	Inch	[m³/h]	[kg]	[EUR]
 <p>Flanschanschluß DIN2634 mit Nut EN1092-1 "D" With Flanged Connection DIN2634 with groove EN1092-1 "D"</p>	2.015.V-RUV/TF	15	1/2"		3,4	423,00 €	
	2.020.V-RUV/TF	20	3/4"		4,1	434,00 €	
	2.025.V-RUV/TF	25	1"		5,0	442,00 €	
	2.032.V-RUV/TF	32	1-1/4"		6,8	580,00 €	
	2.040.V-RUV/TF	40	1-1/2"		10,2	726,00 €	
	2.050.V-RUV/TF	50	2"		11,7	743,00 €	
	2.065.V-RUV/TF	65	2-1/2"		18,6	1.045,00 €	
	2.080.V-RUV/TF	80	3"		23,0	1.085,00 €	
2.100.V-RUV/TF	100	4"		36,0	1.602,00 €		

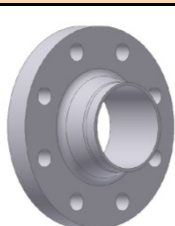
Gegenflansche / Counterflanges		Flansche (2 werden benötigt)		Anschluss		Gewicht	Preis
		Flange (you need 2 pcs.)		Connection		Weight	Price
		Artikel-Nr. / Article-No.	DN	Inch		[kg]	[EUR]
 <p>Stahl, PN25/40 Schweißenden DIN2634 mit Feder EN1092-1 "C" mit Schrauben, Muttern und Dichtungen Steel, PN25/40 ISO Butt Weld Ends DIN2634 with tongue EN1092-1 "C" with bolts, nuts and gasket</p>	FLADINF.015.SMD	15	1/2"		1,8	40,00 €	
	FLADINF.020.SMD	20	3/4"		2,5	42,00 €	
	FLADINF.025.SMD	25	1"		2,9	43,00 €	
	FLADINF.032.SMD	32	1-1/4"		4,1	61,00 €	
	FLADINF.040.SMD	40	1-1/2"		4,8	67,00 €	
	FLADINF.050.SMD	50	2"		6,1	74,00 €	
	FLADINF.065.SMD	65	2-1/2"		9,0	101,00 €	
	FLADINF.080.SMD	80	3"		11,0	111,00 €	
	FLADINF.100.SMD	100	4"		16,5	167,00 €	

Rückschlagventile, Flansch **Check Valve, Flange**

TG: Nur für Verdichterdruckleitung und Sauggasleitung
TG: Only for compressor discharge line and suction line

Flanschventil aus Stahl, PN25

Flanged Valve made of steel, PN25

Auslegung mit V.S.P. Valve Selection Program erforderlich

Selection by V.S.P. Valve Selection Program required

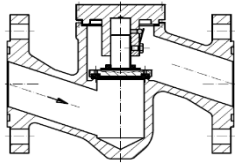
T2V-RUV/TG	Rückschlagventil, Durchg.	Anschluss		Kvs	Gewicht	Preis
	Check Valve, Globe	Connection		Kvs	Weight	Price
	Artikel-Nr. / Article-No.	DN	Inch	[m ³ /h]	[kg]	[EUR]
 <p>Flanschanschluß DIN2634 mit Nut EN1092-1 "D"</p> <p>With Flanged Connection DIN2634 with groove EN1092-1 "D"</p>	2.015.V-RUV/TG	15	1/2"		3,4	423,00 €
	2.020.V-RUV/TG	20	3/4"		4,1	434,00 €
	2.025.V-RUV/TG	25	1"		5,0	442,00 €
	2.032.V-RUV/TG	32	1-1/4"		6,8	580,00 €
	2.040.V-RUV/TG	40	1-1/2"		10,2	726,00 €
	2.050.V-RUV/TG	50	2"		11,7	743,00 €
	2.065.V-RUV/TG	65	2-1/2"		18,6	1.045,00 €
	2.080.V-RUV/TG	80	3"		23,0	1.085,00 €
2.100.V-RUV/TG	100	4"		36,0	1.602,00 €	

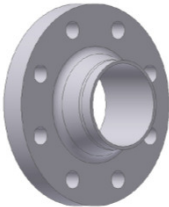
Gegenflansche / Counterflanges	Flansche (2 werden benötigt)	Anschluss		Gewicht	Preis
	Flange (you need 2 pcs.)	Connection		Weight	Price
	Artikel-Nr. / Article-No.	DN	Inch	[kg]	[EUR]
 <p>Stahl, PN25/40 Schweißenden DIN2634 mit Feder EN1092-1 "C" mit Schrauben, Muttern und Dichtungen</p> <p>Steel, PN25/40 ISO Butt Weld Ends DIN2634 with tongue EN1092-1 "C" with bolts, nuts and gasket</p>	FLADINF.015.SMD	15	1/2"	1,8	40,00 €
	FLADINF.020.SMD	20	3/4"	2,5	42,00 €
	FLADINF.025.SMD	25	1"	2,9	43,00 €
	FLADINF.032.SMD	32	1-1/4"	4,1	61,00 €
	FLADINF.040.SMD	40	1-1/2"	4,8	67,00 €
	FLADINF.050.SMD	50	2"	6,1	74,00 €
	FLADINF.065.SMD	65	2-1/2"	9,0	101,00 €
	FLADINF.080.SMD	80	3"	11,0	111,00 €
	FLADINF.100.SMD	100	4"	16,5	167,00 €

Sicherheitsventile BPD Safety Valves BPD

Stahl, bauteilgeprüft, gegendruckabhängig, auch für CO2 geeignet, bei Bestellung bitte Einstelldruck angeben!
Steel, component tested, back pressure dependent, also suitable for CO2, please advice set pressure on order!

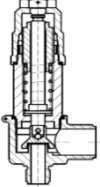
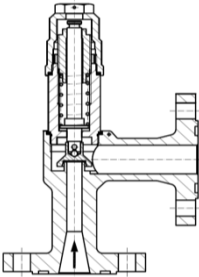
T21.1 NEW		Sicherheitsventil		Anschluss		+ Schweißnippel	Gewicht	Preis	
		Safety Valve		Connection		+ weld nipple	Weight	Price	
		Artikel-Nr. / Article-No.		ein/in	aus/out	ein/in	aus/out	[kg]	[EUR]
		Gewindeanschluss, PN40 Druckbereich 3,5 bis 40 bar ü Threaded ends, PN40 Pressure Range 3.5 to 40 bar g		21.1.012		G1/2"	G1"	-	-
21.1.012.A/B				G1/2"	G1"	-	DN25	2,3	307,00 €
21.1.012.B/B				G1/2"	G1"	DN15	DN25	2,3	338,00 €
21.1.012.C/B				G1/2"	G1"	DN20	DN25	2,3	328,00 €
21.1.012.D/B				G1/2"	G1"	DN25	DN25	2,3	317,00 €
21.1.012.MPT				1/2" MPT	1" MPT	-	-	1,6	259,00 €
TÜV Einstellbescheinigung / Test Certificate by TÜV								Netto-Preis	
Kosten für Bescheinigungen werden netto ohne Abzug berechnet!								Net-Price	
Costs for test certificates will be charged without any discount !								[EUR]	
AZ/SECURITY		Kosten pro Ventil / costs for each valve						44,00 €	
		Sicherheitsventil		Anschluss			Gewicht	Preis	
		Safety Valve		Connection			Weight	Price	
		Artikel-Nr. / Article-No.		ein/in	aus/out		[kg]	[EUR]	
		21.1.015.025.F		DN15	DN25			4,1	452,00 €
21.1.025.025.F		DN25	DN25				4,7	452,00 €	
TÜV Einstellbescheinigung / Test Certificate by TÜV								Netto-Preis	
Kosten für Bescheinigungen werden netto ohne Abzug berechnet!								Net-Price	
Costs for test certificates will be charged without any discount !								[EUR]	
AZ/SECURITY		Kosten pro Ventil / costs for each valve						44,00 €	
		Flansch 1 Stk. (Stückzahl beachten)		Anschluss			Gewicht	Preis	
		Flange 1pc. (take care of quantity)		Connection			Weight	Price	
		Artikel-Nr. / Article-No.		DN	Inch		[kg]	[EUR]	
		FLADINF.015.SMD		15	1/2"			1,8	40,00 €
FLADINF.025.SMD		25	1"				2,9	43,00 €	

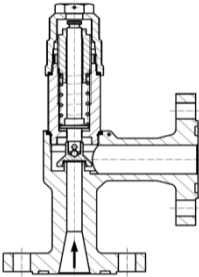
T21.1F NEW		Sicherheitsventil		Anschluss			Gewicht	Preis			
		Safety Valve		Connection			Weight	Price			
		Artikel-Nr. / Article-No.		ein/in	aus/out		[kg]	[EUR]			
		Flanschschluß PN25/40 DIN2634 mit Nut EN1092-1 "D" Druckbereich 3,5 bis 40 bar ü Flanged Connection PN25/40 DIN2634 with groove EN1092-1 "D" Pressure Range 3.5 to 40 bar g		21.1.015.025.F		DN15	DN25		4,1	452,00 €	
21.1.025.025.F				DN25	DN25			4,7	452,00 €		
TÜV Einstellbescheinigung / Test Certificate by TÜV								Netto-Preis			
Kosten für Bescheinigungen werden netto ohne Abzug berechnet!								Net-Price			
Costs for test certificates will be charged without any discount !								[EUR]			
AZ/SECURITY				Kosten pro Ventil / costs for each valve						44,00 €	
		Flansch 1 Stk. (Stückzahl beachten)		Anschluss			Gewicht	Preis			
		Flange 1pc. (take care of quantity)		Connection			Weight	Price			
		Artikel-Nr. / Article-No.		DN	Inch		[kg]	[EUR]			
		FLADINF.015.SMD		15	1/2"			1,8	40,00 €		
FLADINF.025.SMD		25	1"				2,9	43,00 €			

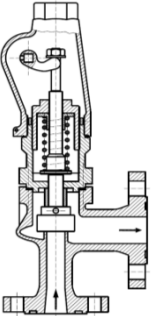
T23.1V NEW		Sicherheitsventil		Anschluss			Gewicht	Preis	
		Safety Valve		Connection			Weight	Price	
		Artikel-Nr. / Article-No.		ein/in	aus/out		[kg]	[EUR]	
		Flanschschluß PN25 DIN2634 mit Nut EN1092-1 "D" Druckbereich 4,5 bis 27 bar ü Flanged Connection PN25 DIN2634 with groove EN1092-1 "D" Pressure Range 4.5 to 27 bar g		23.1.015.025.V		DN15	DN25		8,2
23.1.020.025.V				DN20	DN25			8,2	620,00 €
23.1.025.032.V				DN25	DN32			9,9	637,00 €
23.1.032.040.V				DN32	DN40			10,6	733,00 €
23.1.040.050.V				DN40	DN50			14,5	805,00 €
23.1.050.065.V				DN50	DN65			17,2	815,00 €
TÜV Einstellbescheinigung / Test Certificate by TÜV								Netto-Preis	
Kosten für Bescheinigungen werden netto ohne Abzug berechnet!								Net-Price	
Costs for test certificates will be charged without any discount !								[EUR]	
AZ/SECURITY		Kosten pro Ventil / costs for each valve						44,00 €	
		Flansch 1 Stk. (Stückzahl beachten)		Anschluss			Gewicht	Preis	
		Flange 1pc. (take care of quantity)		Connection			Weight	Price	
		Artikel-Nr. / Article-No.		DN	Inch		[kg]	[EUR]	
		FLADINF.015.SMD		15	1/2"			1,8	40,00 €
FLADINF.020.SMD		20	3/4"				2,5	42,00 €	
FLADINF.025.SMD		25	1"				2,9	43,00 €	
FLADINF.032.SMD		32	1-1/4"				4,1	61,00 €	
FLADINF.040.SMD		40	1-1/2"				4,8	67,00 €	
FLADINF.050.SMD		50	2"				6,1	74,00 €	
FLADINF.065.SMD		65	2-1/2"				9,0	101,00 €	

Dichtungen / Gaskets		Flanschdichtung		Anschluss		Größe		Preis
		Gasket (Flange)		Connection		Size		Price
		Artikel-Nr. / Article-No.		DN	Inch	[mm]		[EUR]
		nur für neue Sicherheitsventile auf alte Wechselventile ! only for new safety valves on old changeover valves !		DI.FLANUT.015.3DK		15	1/2"	39x29x3
DI.FLANUT.020.3DK				20	3/4"	50x36x3		13,00 €
DI.FLANUT.025.3DK				25	1"	57x43x3		18,00 €
DI.FLANUT.032.3DK				32	1-1/4"	65x51x3		18,00 €
DI.FLANUT.040.3DK				40	1-1/2"	75x61x3		18,00 €
DI.FLANUT.050.3DK				50	2"	87x73x3		23,00 €

Bilder sind nur zur Orientierung!
 Pictures are for orientation only!

Sicherheitsventile BPI Safety Valves BPI

Stahl, bauteilgeprüft, gegendruckunabhängig, auch für CO2 geeignet, bei Bestellung bitte Einstelldruck angeben!
Steel, component tested, back pressure independent, also suitable for CO2, please advice set pressure on order!

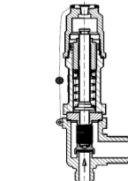
T21.1.FA		Sicherheitsventil	Anschluss		+ Schweißnippel	Gewicht	Preis	
		Safety Valve	Connection		+ weld nipple	Weight	Price	
 <p>Gewindeanschluss, PN40 Druckbereich 6,5 bis 40 bar ü Threaded ends, PN40 Pressure Range 6.5 to 40 bar g</p>		Artikel-Nr. / Article-No.	ein/in	aus/out	ein/in	aus/out	[kg]	[EUR]
		21.1.012.FA	G1/2"	G1"	-	-	1,8	516,00 €
		21.1.012.FA.A/B	G1/2"	G1"	-	DN25	2,5	573,00 €
		21.1.012.FA.B/B	G1/2"	G1"	DN15	DN25	2,5	606,00 €
		21.1.012.FA.C/B	G1/2"	G1"	DN20	DN25	2,5	593,00 €
21.1.012.FA.D/B	G1/2"	G1"	DN25	DN25	2,5	631,00 €		
TÜV Einstellbescheinigung / Test Certificate by TÜV							Netto-Preis	
Kosten für Bescheinigungen werden netto ohne Abzug berechnet!							Net-Price	
Costs for test certificates will be charged without any discount !							[EUR]	
AZ/SECURITY						Kosten pro Ventil / costs for each valve	44,00 €	

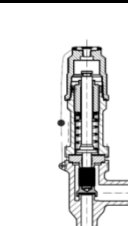
T21.1.F.FA		Sicherheitsventil	Anschluss		Gewicht	Preis	
		Safety Valve	Connection		Weight	Price	
 <p>Flanschschluß PN25/40 DIN2634 mit Nut EN1092-1 "D" Druckbereich 6,5 bis 40 bar ü Flanged Connection PN25/40 DIN2634 with groove EN1092-1 "D" Pressure Range 6.5 to 40 bar g</p>		Artikel-Nr. / Article-No.	ein/in	aus/out	[kg]	[EUR]	
		21.1.015.020.F.FA	DN15	DN20		3,7	730,00 €
		21.1.015.025.F.FA	DN15	DN25		3,7	730,00 €
		21.1.020.020.F.FA	DN20	DN20		3,9	730,00 €
		21.1.020.025.F.FA	DN20	DN25		4,2	730,00 €
21.1.025.025.F.FA	DN25	DN25		4,5	730,00 €		
TÜV Einstellbescheinigung / Test Certificate by TÜV							Netto-Preis
Kosten für Bescheinigungen werden netto ohne Abzug berechnet!							Net-Price
Costs for test certificates will be charged without any discount !							[EUR]
AZ/SECURITY						Kosten pro Ventil / costs for each valve	44,00 €
<p>Stahl, PN25/40 Schweißenden DIN2634 mit Feder EN1092-1 "C" mit Schrauben, Muttern und Dichtungen Steel, PN25/40 ISO Butt Weld Ends DIN2634 with tongue EN1092-1 "C" with bolts, nuts and gasket</p>		Flansch 1 Stk. (Stückzahl beachten)	Anschluss		Gewicht	Preis	
		Flange 1pc. (take care of quantity)	Connection		Weight	Price	
		Artikel-Nr. / Article-No.	DN	Inch	[kg]	[EUR]	
		FLADINF.015.SMD	15	1/2"	1,8	40,00 €	
		FLADINF.020.SMD	20	3/4"	2,5	42,00 €	
FLADINF.025.SMD	25	1"	2,9	43,00 €			

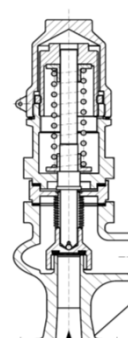
T23.1V.FA NEW		Sicherheitsventil	Anschluss		Gewicht	Preis			
		Safety Valve	Connection		Weight	Price			
 <p>Flanschschluß PN25 DIN2634 mit Nut EN1092-1 "D" Druckbereich 10 bis 27 bar ü Flanged Connection PN25 DIN2634 with groove EN1092-1 "D" Pressure Range 10 to 27 bar g</p>		Artikel-Nr. / Article-No.	ein/in	aus/out	[kg]	[EUR]			
		23.1.025.032.V.FA	DN25	DN32		9,3	1.007,00 €		
		TÜV Einstellbescheinigung / Test Certificate by TÜV							Netto-Preis
		Kosten für Bescheinigungen werden netto ohne Abzug berechnet!							Net-Price
		Costs for test certificates will be charged without any discount !							[EUR]
AZ/SECURITY						Kosten pro Ventil / costs for each valve	44,00 €		
<p>Stahl, PN25/40 Schweißenden DIN2634 mit Feder EN1092-1 "C" mit Schrauben, Muttern und Dichtungen Steel, PN25/40 ISO Butt Weld Ends DIN2634 with tongue EN1092-1 "C" with bolts, nuts and gasket</p>		Flansch 1 Stk. (Stückzahl beachten)	Anschluss		Gewicht	Preis			
		Flange 1pc. (take care of quantity)	Connection		Weight	Price			
		Artikel-Nr. / Article-No.	DN	Inch	[kg]	[EUR]			
		FLADINF.025.SMD	25	3/4"	2,9	43,00 €			
		FLADINF.032.SMD	32	1-1/4"	4,1	61,00 €			

3-Wege-Ventile 3-Way-Valves

handbetätigt, aus Stahl, mit Kappe, PN25
manual actuated, made of steel, with cap, PN25

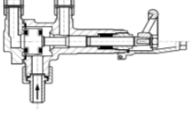
T19A		3-Wegeventil	Anschluss		+ Schweißnippel	Gewicht	Preis	
		3-Way Valves	Connection		+ weld nipple	Weight	Price	
		Artikel-Nr. / Article-No.	ein/in	aus/out	ein/in	aus/out	[kg]	[EUR]
		Gewindeanschluss, PN25 Threaded ends, PN25		19.012.A.K	G1"	G1/2"LH	DN15	-
19.012.A.E:B.K	G1"			G1/2"LH	DN25	-	3,4	494,00 €
Zusammenbaukit für T19 (Sicherheitsventilkombination)							Preis	
Assembling Kit for T19 (Dual-Safety-Valve)							Price	
Artikel-Nr. / Article-No.							[EUR]	
19.012.KIT							für 1xT19A zusammen mit 2xT21	71,00 €

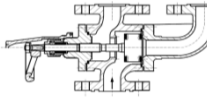
T25V		3-Wegeventil	Anschluss			Gewicht	Preis	
		3-Way Valves	Connection			Weight	Price	
		Artikel-Nr. / Article-No.	ein/in	aus/out		[kg]	[EUR]	
		Flanschschluß PN25 DIN2634 Eintritt Nut EN1092-1 "D" Austritt Feder Form "C" Flanged Connection PN25 DIN2634 inlet groove EN1092-1 "D" outlet tongue face "C"		25.015.V.K	DN15	DN15		10,0
25.020.V.K	DN20			DN20		9,6	580,00 €	
25.025.020.V.K	DN25			DN20		11,7	643,00 €	
25.025.V.K	DN25			DN25		11,7	643,00 €	
25.032.025.V.K	DN32			DN25		14,9	728,00 €	
25.032.V.K	DN32			DN32		14,9	728,00 €	
25.040.032.V.K	DN40			DN32		21,8	931,00 €	
25.040.V.K	DN40			DN40		21,8	931,00 €	
25.050.040.V.K	DN50			DN40		24,7	#NV	
25.050.V.K	DN50			DN50		24,7	946,00 €	
Zusammenbaukit für T19F (Sicherheitsventilkombination)							Preis	
Assembling Kit for T19F (Dual-Safety-Valve)							Price	
Artikel-Nr. / Article-No.							[EUR]	
19.015.F.KIT							für 1xT25V zusammen mit 2xT21F	68,00 €
19.025.F.KIT							für 1xT25V zusammen mit 2xT21F	69,00 €
Zusammenbaukit für T24V (Sicherheitsventilkombination)							Preis	
Assembling Kit for T24V (Dual-Safety-Valve)							Price	
Artikel-Nr. / Article-No.							[EUR]	
24.015.KIT							für 1xT25V zusammen mit 2xT23V	61,00 €
24.020.KIT							für 1xT25V zusammen mit 2xT23V	61,00 €
24.025.KIT							für 1xT25V zusammen mit 2xT23V	62,00 €
24.032.KIT							für 1xT25V zusammen mit 2xT23V	84,00 €
24.040.KIT							für 1xT25V zusammen mit 2xT23V	85,00 €
24.050.KIT							für 1xT25V zusammen mit 2xT23V	86,00 €

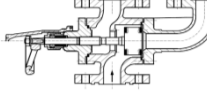
T25V-CO2		3-Wege-Ventil für CO2	Anschluss			Gewicht	Preis
		3-Way Valves	Connection			Weight	Price
		Artikel-Nr. / Article-No.	ein/in	aus/out		[kg]	[EUR]
		Flanschschluß PN25 DIN2634 Eintritt Nut EN1092-1 "D" Austritt Feder Form "C" Flanged Connection PN25 DIN2634 inlet groove EN1092-1 "D" outlet tongue face "C"		25.015.V-CO2.K	DN15	DN15	
25.020.V-CO2.K	DN20			DN20		9,6	892,00 €
25.025.V-CO2.K	DN25			DN25		11,7	991,00 €
25.032.V-CO2.K	DN32			DN32		14,9	1.120,00 €
25.040.V-CO2.K	DN40			DN40		21,8	1.364,00 €
25.050.V-CO2.K	DN50			DN50		24,7	1.665,00 €

Gegenflansche / Counterflanges		Flansche (3 werden benötigt)	Anschluss			Gewicht	Preis
		Flanges (you need 3 pcs.)	Connection			Weight	Price
Stahl, PN25/40 Schweißenden DIN2634 mit Feder EN1092-1 "C" mit Schrauben, Muttern und Dichtungen		Artikel-Nr. / Article-No.	DN	Inch		[kg]	[EUR]
		Steel, PN25/40 ISO Butt Weld Ends DIN2634 with tongue EN1092-1 "C" with bolts, nuts and gasket		FLADINF.015.SMD	15	1/2"	
FLADINF.020.SMD	20			3/4"		2,5	42,00 €
FLADINF.025.SMD	25			1"		2,9	43,00 €
FLADINF.032.SMD	32			1-1/4"		4,1	61,00 €
FLADINF.040.SMD	40			1-1/2"		4,8	67,00 €
FLADINF.050.SMD	50			2"		6,1	74,00 €
FLADINF.065.SMD	65			2-1/2"		9,0	101,00 €

Dichtungen / Gaskets		Flanschdichtung	Inhalt	Anschluss	Größe	Preis	
		Gasket (Flange)	Content	Connection	Size	Price	
Flanschdichtung für Nut EN1092-1 Form D		Artikel-Nr. / Article-No.	[pcs.]	DN	Inch	[mm]	[EUR]
		Gasket (Flange) for groove EN1092-1 "D"		DI.FLANUT.015	1	15	1/2"
DI.FLANUT.020	1			20	3/4"	50x36x2	7,00 €
DI.FLANUT.025	1			25	1"	57x43x2	10,00 €
DI.FLANUT.032	1			32	1-1/4"	65x51x2	10,00 €
DI.FLANUT.040	1			40	1-1/2"	75x61x2	10,00 €
DI.FLANUT.050	1			50	2"	87x73x2	13,00 €
DI.FLANUT.065	1			65	2-1/2"	109x95x2	15,00 €

Schrauben, Muttern / Bolts, Nuts		Schrauben/Mutternsatz	Inhalt	Anschluss	Größe	Preis	
		Bolts/Nuts Kit	Content	Connection	Size	Price	
		Artikel-Nr. / Article-No.	[pcs.]	DN	Inch	[mm]	[EUR]
		Schrauben/Mutternsatz Bolts/Nuts Kit		SM.015.FLADIN	4	15-25	1/2" to 1"
SM.032.FLADIN	4			32-50	1-1/4" to 2"	M16x55	39,00 €
SM.065.FLADIN	8			65	2-1/2"	M16x60	75,00 €

Bilder sind nur zur Orientierung!
Pictures are for orientation only!

Sicherheitsventil-Kombi. BPD **Dual Safety Valves BPD**

Stahl, bauteilgeprüft, gegendruckabhängig, bei Bestellung bitte Einstelldruck angeben!
Steel, component tested, back pressure dependent, please advice set pressure on order!

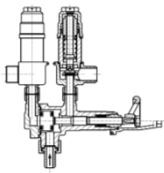
T19.1 NEW		Gewindeanschluss, PN40 Druckbereich 3,5 bis 40 bar Threaded ends, PN40 Pressure Range 3.5 to 40 bar g	Sicherheitsventilkombi.	Anschluss		+ Schweißnippel	Gewicht	Preis	
			Dual Safety Valve	Connection		+ weld nipple	Weight	Price	
			Artikel-Nr. / Article-No.	ein/in	aus/out	ein/in	aus/out	[kg]	[EUR]
			19.1.012.K	G1"	G1"	DN15	-	6,0	#NV
			19.1.012.S/B.K	G1"	G1"	DN15	DN25	7,2	#NV
			19.1.012.B/B.K	G1"	G1"	DN25	DN25	8,0	#NV
TÜV Einstellbescheinigung / Test Certificate by TÜV							Netto-Preis		
Kosten für Bescheinigungen werden netto ohne Abzug berechnet!							Net-Price		
Costs for test certificates will be charged without any discount !							[EUR]		
AZ/SECURITY COMBI							88,00 €		

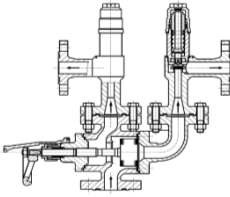
T19.1F NEW		Flanschschluß PN25 DIN2634 mit Nut EN1092-1 "D" Druckbereich 3,5 bis 40 bar ü Flanged Connection PN25 DIN2634 with groove EN1092-1 "D" Pressure Range 3.5 to 40 bar Stahl, PN25/40 Schweißenden DIN2634 mit Feder EN1092-1 "C" mit Schrauben, Muttern und Dichtungen Steel, PN25/40 ISO Butt Weld Ends DIN2634 with tongue EN1092-1 "C" with bolts, nuts and gasket	Sicherheitsventilkombi.	Anschluss		Gewicht	Preis	
			Dual Safety Valve	Connection		Weight	Price	
			Artikel-Nr. / Article-No.	ein/in	aus/out	[kg]	[EUR]	
			19.1.015.025.F.K	DN15	DN25	17,2	1.514,00 €	
			19.1.025.025.F.K	DN25	DN25	21,6	1.587,00 €	
TÜV Einstellbescheinigung / Test Certificate by TÜV							Netto-Preis	
Kosten für Bescheinigungen werden netto ohne Abzug berechnet!							Net-Price	
Costs for test certificates will be charged without any discount !							[EUR]	
AZ/SECURITY Combi							88,00 €	
Flansch 1 Stk. (Stückzahl beachten)			Anschluss		Gewicht	Preis		
Flange 1pc. (take care of quantity)			Connection		Weight	Price		
Artikel-Nr. / Article-No.			DN	Inch	[kg]	[EUR]		
FLADINF.015.SMD			15	1/2"	1,8	40,00 €		
FLADINF.025.SMD			25	1"	2,9	43,00 €		

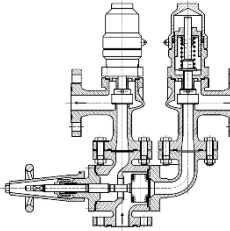
T24.1V NEW		Flanschschluß PN25 DIN2634 mit Nut EN1092-1 "D" Druckbereich 4,5 bis 27 bar Flanged Connection PN25 DIN2634 with groove EN1092-1 "D" Pressure Range 4.5 to 27 bar g Stahl, PN25/40 Schweißenden DIN2634 mit Feder EN1092-1 "C" mit Schrauben, Muttern und Dichtungen Steel, PN25/40 ISO Butt Weld Ends DIN2634 with tongue EN1092-1 "C" with bolts, nuts and gasket	Sicherheitsventilkombi.	Anschluss		Gewicht	Preis	
			Dual Safety Valve	Connection		Weight	Price	
			Artikel-Nr. / Article-No.	ein/in	aus/out	[kg]	[EUR]	
			24.1.015.025.V.K	DN15	DN25	23,8	1.858,00 €	
			24.1.020.025.V.K	DN20	DN25	23,8	1.870,00 €	
			24.1.025.032.V.K	DN25	DN32	32,0	1.966,00 €	
			24.1.032.032.V.K	DN32	DN32	NEW	2.055,00 €	
			24.1.032.040.V.K	DN32	DN40	37,0	2.262,00 €	
			24.1.040.040.V.K	DN40	DN40	NEW	2.462,00 €	
			24.1.040.050.V.K	DN40	DN50	54,0	2.605,00 €	
			24.1.050.050.V.K	DN50	DN50	NEW	2.626,00 €	
			24.1.050.065.V.K	DN50	DN65	60,0	2.636,00 €	
TÜV Einstellbescheinigung / Test Certificate by TÜV							Netto-Preis	
Kosten für Bescheinigungen werden netto ohne Abzug berechnet!							Net-Price	
Costs for test certificates will be charged without any discount !							[EUR]	
AZ/SECURITY COMBI							88,00 €	
Flansch 1 Stk. (Stückzahl beachten)			Anschluss		Gewicht	Preis		
Flange 1pc. (take care of quantity)			Connection		Weight	Price		
Artikel-Nr. / Article-No.			DN	Inch	[kg]	[EUR]		
FLADINF.015.SMD			15	1/2"	1,8	40,00 €		
FLADINF.020.SMD			20	3/4"	2,5	42,00 €		
FLADINF.025.SMD			25	1"	2,9	43,00 €		
FLADINF.032.SMD			32	1-1/4"	4,1	61,00 €		
FLADINF.040.SMD			40	1-1/2"	4,8	67,00 €		
FLADINF.050.SMD			50	2"	6,1	74,00 €		
FLADINF.065.SMD			65	2-1/2"	9,0	101,00 €		

Dichtungen / Gaskets		Flanschdichtung	Inhalt	Anschluss	Größe	Preis	
		Gasket (Flange)	Content	Connection	Size	Price	
		Artikel-Nr. / Article-No.	[pcs.]	DN	Inch	[mm]	
Flanschdichtung für Nut EN1092-1 Form D	Gasket (Flange) for groove EN1092-1 "D"	DI.FLANUT.015	1	15	1/2"	39x29x2	7,00 €
		DI.FLANUT.020	1	20	3/4"	50x36x2	7,00 €
		DI.FLANUT.025	1	25	1"	57x43x2	10,00 €
		DI.FLANUT.032	1	32	1-1/4"	65x51x2	10,00 €
		DI.FLANUT.040	1	40	1-1/2"	75x61x2	10,00 €
		DI.FLANUT.050	1	50	2"	87x73x2	13,00 €
		DI.FLANUT.065	1	65	2-1/2"	109x95x2	15,00 €

Sicherheitsventil-Kombinationen BPI **Dual Safety Valves BPI**

Stahl, bauteilgeprüft, gegendruckunabhängig, bei Bestellung bitte Einstelldruck angeben!
Steel, component tested, back pressure independent, please advice set pressure on order!

T19FA		Sicherheitsventilkombi.	Anschluss		+ Schweißnippel	Gewicht	Preis	
		Dual Safety Valve	Connection		+ weld nipple	Weight	Price	
		Artikel-Nr. / Article-No.	ein/in	aus/out	ein/in	aus/out	[kg] [EUR]	
	Gewindeanschluss, PN40 Druckbereich 6,5 bis 40 bar ü Threaded ends, PN40 Pressure Range 6.5 to 40 bar g	19.1.012.FA.S/B.K	G1/2"	G1"	DN15	DN25	7,5 on request	
		19.1.012.FA.B/B.K	G1/2"	G1"	DN25	DN25	8,0 on request	
		TÜV Einstellbescheinigung / Test Certificate by TÜV						Netto-Preis
		Kosten für Bescheinigungen werden netto ohne Abzug berechnet!						Net-Price
		Costs for test certificates will be charged without any discount !						[EUR]
		AZ/SECURITY COMBI					88,00 €	

T19F.FA		Sicherheitsventilkombi.	Anschluss			Gewicht	Preis
		Dual Safety Valve	Connection			Weight	Price
		Artikel-Nr. / Article-No.	ein/in	aus/out		[kg]	[EUR]
	Flanschschluß PN25 DIN2634 mit Nut EN1092-1 "D" Druckbereich 6,5 bis 40 bar ü Flanged Connection PN25 DIN2634 with groove EN1092-1 "D" Pressure Range 6.5 to 40 bar	19.1.015.020.F.FA.K	15	20		16,6	on request
		19.1.020.020.F.FA.K	20	20		18,0	on request
		19.1.020.025.F.FA.K	20	25		19,0	on request
		19.1.025.025.F.FA.K	25	25		20,0	on request
		TÜV Einstellbescheinigung / Test Certificate by TÜV					
Kosten für Bescheinigungen werden netto ohne Abzug berechnet!						Net-Price	
Costs for test certificates will be charged without any discount !						[EUR]	
		AZ/SECURITY COMBI					88,00 €
		Flansch 1 Stk. (Stückzahl beachten)	Anschluss			Gewicht	Preis
		Flange 1pc. (take care of quantity)	Connection			Weight	Price
		Artikel-Nr. / Article-No.	DN	Inch		[kg]	[EUR]
Stahl, PN25/40 Schweißenden DIN2634 mit Feder EN1092-1 "C" mit Schrauben, Muttern und Dichtungen Steel, PN25/40 ISO Butt Weld Ends DIN2634 with tongue EN1092-1 "C" with bolts, nuts and gasket		FLADINF.015.SMD	15	1/2"		1,8	40,00 €
		FLADINF.020.SMD	20	3/4"		2,5	42,00 €
		FLADINF.025.SMD	25	1"		2,9	43,00 €

T24V.FA		Sicherheitsventilkombi.	Anschluss			Gewicht	Preis	
		Dual Safety Valve	Connection			Weight	Price	
		Artikel-Nr. / Article-No.	ein/in	aus/out		[kg]	[EUR]	
	Flanschschluß PN25 DIN2634 mit Nut EN1092-1 "D" Druckbereich 10 bis 27 bar ü Flanged Connection PN25 DIN2634 with groove EN1092-1 "D" Pressure Range 10 to 27 bar g	24.1.025.032.V.FA.K	DN25	DN32		30,3	on request	
		TÜV Einstellbescheinigung / Test Certificate by TÜV						Netto-Preis
		Kosten für Bescheinigungen werden netto ohne Abzug berechnet!						Net-Price
		Costs for test certificates will be charged without any discount !						[EUR]
				AZ/SECURITY COMBI				
		Flansch 1 Stk. (Stückzahl beachten)	Anschluss			Gewicht	Preis	
		Flange 1pc. (take care of quantity)	Connection			Weight	Price	
		Artikel-Nr. / Article-No.	DN	Inch		[kg]	[EUR]	
Stahl, PN25/40 Schweißenden DIN2634 mit Feder EN1092-1 "C" mit Schrauben, Muttern und Dichtungen Steel, PN25/40 ISO Butt Weld Ends DIN2634 with tongue EN1092-1 "C" with bolts, nuts and gasket		FLADINF.025.SMD	15	1/2"		1,8	43,00 €	
		FLADINF.032.SMD	32	1-1/4"		2,5	61,00 €	

Serviceventile VA

Service Valves SS

Edelstahl, handbetätigt, mit Spindelkappe, alternativ mit Handrad
Stainless steel, manual actuated, with cap stem, alternativ with handwheel

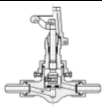
T34VA		Absperrentil, Durchgang	Sitz	Anschluss		Gewicht	Preis
		Shut Off Valve, Globe	Seat	Connection			
 mit Schweiß-Tüllen with nut and tail		Artikel-Nr. / Article-No.	[mm]	[inch]	[mm]	[kg]	[EUR]
		34.006.VA.K	6	G1/2"	13 x 3,5	0,8	262,00 €
		34.008.VA.K	8	G3/4"	17 x 4,5	1,2	298,00 €
		34.010.VA.K	10	G3/4"	17 x 3,5	1,2	298,00 €
		34.012.VA.K	12	G1"	22 x 5,0	1,6	348,00 €

T37VA		Absperrentil, Eck	Sitz	Anschluss		Gewicht	Preis
		Shut Off Valve, Angle	Seat	Connection			
 mit Schweiß-Tüllen with nut and tail		Artikel-Nr. / Article-No.	[mm]	[inch]	[mm]	[kg]	[EUR]
		37.006.VA.K	6	G1/2"	13 x 3,5	0,8	262,00 €
		37.008.VA.K	8	G3/4"	17 x 4,5	0,8	298,00 €
		37.010.VA.K	10	G3/4"	17 x 3,5	0,8	298,00 €
		37.012.VA.K	12	G1"	22 x 5,0	0,8	348,00 €

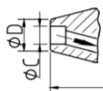
T34VA.S1		Serviceventil, Durchgang	Anschluss		Gewicht	Preis	
		Service Valve, Globe	Connection				
Eintitt / inlet		Austritt / outlet	Artikel-Nr. / Article-No.	Ein/in	Austritt / outlet	[kg]	[EUR]
			34.006.VA.S1.K	13,5mm	G1/2"+Tülle 13,5	0,7	228,00 €
			34.006.VA.S1.0.K	17,5mm	G1/2"+Tülle 13,5	0,7	228,00 €
			34.006.VA.S1.1.K	21,5mm	G1/2"+Tülle 13,5	0,7	228,00 €

T37VA.S1		Serviceventil, Eck	Anschluss		Gewicht	Preis	
		Service Valve, Angle	Connection				
Eintitt / inlet		Austritt / outlet	Artikel-Nr. / Article-No.	Ein/in	Austritt / outlet	[kg]	[EUR]
			37.006.VA.S1.K	13,5mm	G1/2"+Tülle 13,5	0,7	228,00 €
			37.006.VA.S1.0.K	17,5mm	G1/2"+Tülle 13,5	0,7	228,00 €
			37.006.VA.S1.1.K	21,5mm	G1/2"+Tülle 13,5	0,7	228,00 €

T34VA.S2		Serviceventil, Durchgang	Anschluss		Gewicht	Preis	
		Service Valve, Globe	Connection				
Eintitt / inlet		Austritt / outlet	Artikel-Nr. / Article-No.	Ein/in	Austritt / outlet	[kg]	[EUR]
			34.006.VA.S2.K	13,5mm	G1/2" Blindmutter/Blind Nut	0,7	228,00 €
			34.006.VA.S2.0.K	17,5mm	G1/2" Blindmutter/Blind Nut	0,7	228,00 €
			34.006.VA.S2.1.K	21,5mm	G1/2" Blindmutter/Blind Nut	0,7	228,00 €

T37VA.S2		Serviceventil, Eck	Anschluss		Gewicht	Preis	
		Service Valve, Angle	Connection				
Eintitt / inlet		Austritt / outlet	Artikel-Nr. / Article-No.	Ein/in	Austritt / outlet	[kg]	[EUR]
			37.006.VA.S2.K	13,5mm	G1/2" Blindmutter/Blind Nut	0,7	228,00 €
			37.006.VA.S2.0.K	17,5mm	G1/2" Blindmutter/Blind Nut	0,7	228,00 €
			37.006.VA.S2.1.K	21,5mm	G1/2" Blindmutter/Blind Nut	0,7	228,00 €

T34VA.S3		Ermetoventil, Durchgang	Anschluss		Gewicht	Preis	
		Ermeto Valve, Globe	Connection				
Eintitt / inlet	 S3... S3.3	Austritt / outlet	Artikel-Nr. / Article-No.	Ein/in	Austritt / outlet	[kg]	[EUR]
			34.006.VA.S3.K	13,5mm	10mm Ermeto	0,7	282,00 €
			34.006.VA.S3.0.K	17,5mm	10mm Ermeto	0,7	282,00 €
			34.006.VA.S3.1.K	21,3mm	10mm Ermeto	0,7	282,00 €
			34.006.VA.S3.3.K	G1/2"+Tülle 13,5	10mm Ermeto	0,7	282,00 €

T37VA.S3		Ermetoventil, Eck	Anschluss		Gewicht	Preis	
		Ermeto Valve, Angle	Connection				
Eintitt / inlet	 S3... S3.3	Austritt / outlet	Artikel-Nr. / Article-No.	Ein/in	Austritt / outlet	[kg]	[EUR]
			37.006.VA.S3.K	13,5mm	10mm Ermeto	0,7	282,00 €
			37.006.VA.S3.0.K	17,5mm	10mm Ermeto	0,7	282,00 €
			37.006.VA.S3.1.K	21,3mm	10mm Ermeto	0,7	282,00 €
			37.006.VA.S3.3.K	G1/2"+Tülle 13,5	10mm Ermeto	0,7	282,00 €

Serviceventile VA

Service Valves SS

Edelstahl, handbetätigt, mit Spindelkappe, alternativ mit Handrad
Stainless steel, manual actuated, with cap stem, alternativ with handwheel

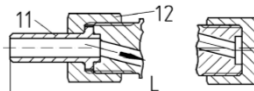
T34VA.S4	Serviceventil, Durchgang	Anschluss		Gewicht	Preis
	Service Valve, Globe	Connection		Weight	Price
	Artikel-Nr. / Article-No.	Ein/in	Austritt / outlet	[kg]	[EUR]
Eintitt / inlet  Austritt / outlet	34.006.VA.S4.K	G1/2"+Tülle 13,5	Blindmutter	0,7	228,00 €
		G1/2"+Tail 13,5	Blind Nut		

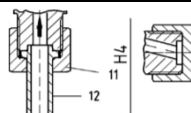
T37VA.S4	Serviceventil, Eck	Anschluss		Gewicht	Preis
	Service Valve, Angle	Connection		Weight	Price
	Artikel-Nr. / Article-No.	Ein/in	Austritt / outlet	[kg]	[EUR]
Eintitt / inlet  Austritt / outlet	37.006.VA.S4.K	G1/2"+Tülle 13,5	Blindmutter	0,7	228,00 €
		G1/2"+Tail 13,5	Blind Nut		

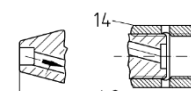
T34VA.S6	Manometerventil, Durchg.	Anschluss		Gewicht	Preis
	Gauge Valve, Globe	Connection		Weight	Price
	Artikel-Nr. / Article-No.	Ein/in	Austritt / outlet	[kg]	[EUR]
Eintitt / inlet  Austritt / outlet	34.006.VA.S6.K	13,5mm	G1/2" R/L	0,7	228,00 €
	34.006.VA.S6.0.K	17,5mm	G1/2" R/L	0,7	228,00 €
	34.006.VA.S6.1.K	21,3mm	G1/2" R/L	0,7	228,00 €
	34.006.VA.S6.3.K	G1/2"+Tülle 13,5	G1/2" R/L	0,7	228,00 €

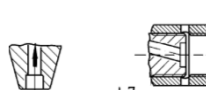
T37VA.S6	Manometerventil, Eck	Anschluss		Gewicht	Preis
	Gauge Valve, Angle	Connection		Weight	Price
	Artikel-Nr. / Article-No.	Ein/in	Austritt / outlet	[kg]	[EUR]
Eintitt / inlet  Austritt / outlet	37.006.VA.S6.K	13,5mm	G1/2" R/L	0,7	228,00 €
	37.006.VA.S6.0.K	17,5mm	G1/2" R/L	0,7	228,00 €
	37.006.VA.S6.1.K	21,3mm	G1/2" R/L	0,7	228,00 €
	37.006.VA.S6.3.K	G1/2"+Tülle 13,5	G1/2" R/L	0,7	228,00 €

T34VA.S9.3.1	3-Wege-Manometerventil	Anschluss		Gewicht	Preis
	3-Way Gauge Valve	Connection		Weight	Price
	Artikel-Nr. / Article-No.	Ein/in	Austritt / outlet	[kg]	[EUR]
	34.006.VA.S9.3.1.K	21,3mm	G1/2" R/L	0,7	299,00 €

Serviceventile VA Service Valves SS

Edelstahl, handbetätigt, mit Spindelkappe, alternativ mit Handrad
Stainless steel, manual actuated, with cap stem, alternativ with handwheel

T64VA.S2.1	Serviceventil, Durchgang	Anschluss		Gewicht	Preis
	Service Valve, Globe	Connection		Weight	Price
	Artikel-Nr. / Article-No.	Ein/in	Austritt / outlet	[kg]	[EUR]
	64.VA.2.1.K	DN15	G1/2" Blindmutter/Blind Nut	0,7	190,00 €

T63VA.S2.1	Serviceventil, Eck	Anschluss		Gewicht	Preis
	Service Valve, Angle	Connection		Weight	Price
	Artikel-Nr. / Article-No.	Ein/in	Austritt / outlet	[kg]	[EUR]
	63.VA.2.1.K	DN15	G1/2" Blindmutter/Blind Nut	0,7	184,00 €

T64VA.S6.1	Manometerventil, Durchg.	Anschluss		Gewicht	Preis
	Gauge Valve, Globe	Connection		Weight	Price
	Artikel-Nr. / Article-No.	Ein/in	Austritt / outlet	[kg]	[EUR]
	64.VA.6.1.K	DN15	G1/2" R/L	0,7	190,00 €

T63VA.S6.1	Manometerventil, Eck	Anschluss		Gewicht	Preis
	Gauge Valve, Angle	Connection		Weight	Price
	Artikel-Nr. / Article-No.	Ein/in	Austritt / outlet	[kg]	[EUR]
	63.VA.6.1.K	DN15	G1/2" R/L	0,7	190,00 €

T63VA.S20.1	Serviceventil, Eck	Anschluss		Gewicht	Preis
	Service Valve, Angle	Connection		Weight	Price
	Artikel-Nr. / Article-No.	Ein/in	Austritt / outlet	[kg]	[EUR]
	63.VA.20.1.K	DN15	G1/2" Kappe/Cap	0,7	175,00 €

Ölablassventil VA Oil Drain Valve SS

Edelstahl, handbetätigt
Stainless Steel, manual actuated

T38VA.E	Ölablassventil, Eck	Anschluss		Gewicht	Preis
	Oil Drain Valve, Angle	Connection		Weight	Price
	Artikel-Nr. / Article-No.	DN	Inch	[kg]	[EUR]
	38.015.VA.E	15	1/2"	2,5	559,00 €

Absperrventile VA

Shut-Off Valves SS

Standard: handbetätigt, aus Edelstahl, mit ISO Anschweißenden, Kappe, PN25
Standard: manual actuated, made of stainless steel, with butt weld ends ISO, cap, PN25
Alternative: Anschweißenden mit Schweißfase nach ANSI, Schedule, mit Handrad
Alternative: butt weld ends according ANSI, Schedule, with handwheel

T5VA		Absperrventil, Durchgang	Anschluss		Kvs	Gewicht	Preis
		Shut Off Valve, Globe	Connection		Kvs	Weight	Price
		Artikel-Nr. / Article-No.	DN	Inch	[m³/h]	[kg]	[EUR]
	Oberteil geschraubt Screwed bonnet	5.006.VA.K	6	1/4"	0,73	0,6	on request
		5.008.VA.K	8	5/16"	1,35	0,9	on request
		5.012.VA.K	12	1/2"	2,13	0,9	on request

T6VA		Absperrventil, Eck	Connection		Kvs	Weight	Price
		Shut Off Valve, Angle	Connection		Kvs	Weight	Price
		Artikel-Nr. / Article-No.	DN	Inch	[m³/h]	[kg]	[EUR]
	Oberteil geschraubt Screwed bonnet	6.006.VA.K	6	1/4"	1,06	0,5	on request
		6.008.VA.K	8	5/16"	1,80	0,8	on request
		6.012.VA.K	12	1/2"	4,04	0,8	on request

T5VA.F		Absperrventil, Durchgang	Anschluss		Kvs	Gewicht	Preis
		Shut Off Valve, Globe	Connection		Kvs	Weight	Price
		Artikel-Nr. / Article-No.	DN	Inch	[m³/h]	[kg]	[EUR]
	Oberteil geflanscht Bolted bonnet	5.015.VA.F.K	15	1/2"	3,1	1,4	251,00 €
		5.020.VA.F.K	20	3/4"	6,1	1,6	292,00 €
		5.025.VA.F.K	25	1"	10,0	2,9	388,00 €
		5.032.VA.F.K	32	1-1/4"	15,0	3,5	453,00 €
		5.040.VA.F.K	40	1-1/2"	23,3	4,3	607,00 €
		5.050.VA.F.K	50	2"	38,1	6,3	781,00 €
	Oberteil geflanscht Bolted bonnet	5.065.VA.F.K	65	2-1/2"	69,6	19,1	1.697,00 €
		5.080.VA.F.K	80	3"	100	21,2	1.769,00 €
		5.100.VA.F.K	100	4"	159	30,0	1.894,00 €
		5.125.VA.F.K	125	5"	242	50,0	3.403,00 €
		5.150.VA.F.K	150	6"	406	82,0	3.692,00 €
		5.200.VA.F.K	200	8"	628	139,0	7.071,00 €

T6VA.F		Absperrventil, Eck	Anschluss		Kvs	Gewicht	Preis
		Shut Off Valve, Angle	Connection		Kvs	Weight	Price
		Artikel-Nr. / Article-No.	DN	Inch	[m³/h]	[kg]	[EUR]
	Oberteil geflanscht Bolted bonnet	6.015.VA.F.K	15	1/2"	3,6	1,3	240,00 €
		6.020.VA.F.K	20	3/4"	8,0	1,4	289,00 €
		6.025.VA.F.K	25	1"	15,6	2,7	380,00 €
		6.032.VA.F.K	32	1-1/4"	28,4	2,9	442,00 €
		6.040.VA.F.K	40	1-1/2"	28,5	3,8	490,00 €
		6.050.VA.F.K	50	2"	53,7	4,9	583,00 €
		6.065.VA.F.K	65	2-1/2"	84	13,5	1.318,00 €
		6.080.VA.F.K	80	3"	149	14,7	1.555,00 €
		6.100.VA.F.K	100	4"	218	20,6	1.626,00 €
		6.125.VA.F.K	125	5"	418	36,0	2.931,00 €
		6.150.VA.F.K	150	6"	607	55,0	3.108,00 €
		6.200.VA.F.K	200	8"	942	82,0	4.747,00 €

Absperrventile VA

Shut-Off Valves SS

Standard: handbetätigt, aus Edelstahl, mit ISO Anschweißenden, Kappe, PN25
Standard: manual actuated, made of stainless steel, with butt weld ends ISO, cap, PN25
Alternative: Anschweißenden mit Schweißfase nach ANSI, Schedule, mit Handrad
Alternative: butt weld ends according ANSI, Schedule, with handwheel

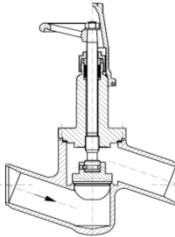
T5VA.F.L		Absperrventil, Durchgang	Anschluss		Kvs	Gewicht	Preis
		Shut Off Valve, Globe	Connection		Kvs	Weight	Price
 Verlängertes Oberteil Extended bonnet		Artikel-Nr. / Article-No.	DN	Inch	[m³/h]	[kg]	[EUR]
		5.015.VA.F.L.K	15	1/2"	3,1	1,8	282,00 €
5.020.VA.F.L.K	20	3/4"	6,1	1,9	322,00 €		
5.025.VA.F.L.K	25	1"	10,0	3,4	430,00 €		
5.032.VA.F.L.K	32	1-1/4"	15,0	3,7	499,00 €		
5.040.VA.F.L.K	40	1-1/2"	23,3	5,2	695,00 €		
5.050.VA.F.L.K	50	2"	38,1	6,4	922,00 €		
5.065.VA.F.L.K	65	2-1/2"	69,6	22,0	1.990,00 €		
5.080.VA.F.L.K	80	3"	100	27,0	2.063,00 €		
5.100.VA.F.L.K	100	4"	159	32,0	2.189,00 €		

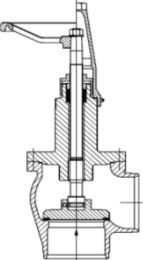
T6VA.F.L		Absperrventil, Eck	Connection		Kvs	Weight	Price
		Shut Off Valve, Angle	Connection		Kvs	Weight	Price
 Verlängertes Oberteil Extended bonnet		Artikel-Nr. / Article-No.	DN	Inch	[m³/h]	[kg]	[EUR]
		6.015.VA.F.L.K	15	1/2"	3,6	1,5	268,00 €
6.020.VA.F.L.K	20	3/4"	8,0	1,7	319,00 €		
6.025.VA.F.L.K	25	1"	15,6	3,0	420,00 €		
6.032.VA.F.L.K	32	1-1/4"	28,4	3,5	483,00 €		
6.040.VA.F.L.K	40	1-1/2"	28,5	4,1	545,00 €		
6.050.VA.F.L.K	50	2"	53,7	5,4	719,00 €		
6.065.VA.F.L.K	65	2-1/2"	84	16,7	1.615,00 €		
6.080.VA.F.L.K	80	3"	149	20,2	1.851,00 €		
6.100.VA.F.L.K	100	4"	218	24,0	1.923,00 €		

Absperrventile VA, FABA

Shut-Off Valves SS, Bellows

Standard: handbetätigt, aus Edelstahl, mit ISO Anschweißenden, Kappe, PN25
Standard: manual actuated, made of stainless steel, with butt weld ends ISO, cap, PN25
Alternative: Anschweißenden mit Schweißfase nach ANSI, Schedule, mit Handrad
Alternative: butt weld ends according ANSI, Schedule, with handwheel

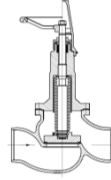
T5VA.F.FA		Absperrventil, Durchgang	Anschluss		Kvs	Gewicht	Preis
		Shut Off Valve, Globe	Connection		Kvs	Weight	Price
 Spindelabdichtung: Faltenbalg Oberteil geflanscht Stem Sealing: Bellows Seal Bolted bonnet		Artikel-Nr. / Article-No.	DN	Inch	[m³/h]	[kg]	[EUR]
		5.015.VA.F.FA.K	15	1/2"	3,1	1,8	813,00 €
5.020.VA.F.FA.K	20	3/4"	6,1	2,0	848,00 €		
5.025.VA.F.FA.K	25	1"	10,0	3,5	1.118,00 €		
5.032.VA.F.FA.K	32	1-1/4"	15,0	4,0	1.171,00 €		
5.040.VA.F.FA.K	40	1-1/2"	23,3	5,5	1.498,00 €		
5.050.VA.F.FA.K	50	2"	38,1	7,2	1.786,00 €		
5.065.VA.F.FA.K	65	2-1/2"	69,6	24,0	3.048,00 €		
5.080.VA.F.FA.K	80	3"	100	26,5	3.373,00 €		
5.100.VA.F.FA.K	100	4"	159	33,0	3.963,00 €		

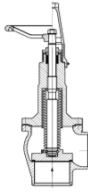
T6VA.F.FA		Absperrventil, Eck	Anschluss		Kvs	Gewicht	Preis
		Shut Off Valve, Angle	Connection		Kvs	Weight	Price
 Spindelabdichtung: Faltenbalg Oberteil geflanscht Stem Sealing: Bellows Seal Bolted bonnet		Artikel-Nr. / Article-No.	DN	Inch	[m³/h]	[kg]	[EUR]
		6.015.VA.F.FA.K	15	1/2"	3,6	1,6	805,00 €
6.020.VA.F.FA.K	20	3/4"	8,0	1,7	840,00 €		
6.025.VA.F.FA.K	25	1"	15,6	3,2	1.114,00 €		
6.032.VA.F.FA.K	32	1-1/4"	28,4	3,7	1.164,00 €		
6.040.VA.F.FA.K	40	1-1/2"	28,5	4,7	1.381,00 €		
6.050.VA.F.FA.K	50	2"	53,7	5,9	1.708,00 €		
6.065.VA.F.FA.K	65	2-1/2"	84	18,9	2.771,00 €		
6.080.VA.F.FA.K	80	3"	149	20,3	3.027,00 €		
6.100.VA.F.FA.K	100	4"	218	24,4	3.595,00 €		

Absperrentile CO² Edelstahl Shut-Off Valves CO² Stainless Steel

Standard: handbetätigt, aus Edelstahl, mit ISO Anschweißenden, Kappe, PN40
Standard: manual actuated, made of stainless steel, with butt weld ends ISO, cap, PN40
Alternative: Anschweißenden mit Schweißfase nach ANSI, Schedule, mit Handrad
Alternative: butt weld ends according ANSI, Schedule, with handwheel

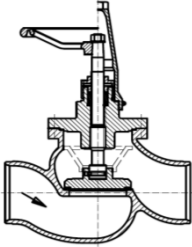
T5VA.F-CO2		absperrentil, Durchgang	Anschluss		Kvs	Gewicht	Preis
		Shut Off Valve, Globe	Connection		Kvs	Weight	Price
		Artikel-Nr. / Article-No.	DN	Inch	[m³/h]	[kg]	[EUR]
		Oberteil geflanscht Für trockenes CO ₂ Bolted bonnet For dry CO ₂		5.015.VA.F-CO2.K	15	1/2"	3,1
5.020.VA.F-CO2.K	20			3/4"	6,1	1,6	300,00 €
5.025.VA.F-CO2.K	25			1"	10,0	2,9	403,00 €
5.032.VA.F-CO2.K	32			1-1/4"	15,0	3,5	464,00 €
5.040.VA.F-CO2.K	40			1-1/2"	23,3	4,3	623,00 €
5.050.VA.F-CO2.K	50			2"	38,1	6,3	798,00 €
5.065.VA.F-CO2.K	65			2-1/2"	69,6	19,1	1.736,00 €
5.080.VA.F-CO2.K	80			3"	100	21,2	1.809,00 €
5.100.VA.F-CO2.K	100			4"	159	30,0	1.934,00 €
5.125.VA.F-CO2.K	125			5"	242	50,0	3.369,00 €
5.150.VA.F-CO2.K	150			6"	406	82,0	3.674,00 €
5.200.VA.F-CO2.K	200	8"	628	139,0	7.171,00 €		

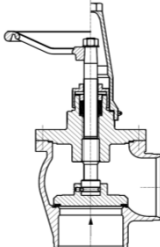
T6VA.F-CO2		Absperrentil, Eck	Anschluss		Kvs	Gewicht	Preis
		Shut Off Valve, Angle	Connection		Kvs	Weight	Price
		Artikel-Nr. / Article-No.	DN	Inch	[m³/h]	[kg]	[EUR]
		Oberteil geflanscht Für trockenes CO ₂ Bolted bonnet For dry CO ₂		6.015.VA.F-CO2.K	15	1/2"	3,6
6.020.VA.F-CO2.K	20			3/4"	8,0	1,4	295,00 €
6.025.VA.F-CO2.K	25			1"	15,6	2,7	395,00 €
6.032.VA.F-CO2.K	32			1-1/4"	28,4	2,9	454,00 €
6.040.VA.F-CO2.K	40			1-1/2"	28,5	3,8	503,00 €
6.050.VA.F-CO2.K	50			2"	53,7	4,9	604,00 €
6.065.VA.F-CO2.K	65			2-1/2"	84	13,5	1.359,00 €
6.080.VA.F-CO2.K	80			3"	149	14,7	1.595,00 €
6.100.VA.F-CO2.K	100			4"	218	20,6	1.668,00 €
6.125.VA.F-CO2.K	125			5"	418	36,0	2.993,00 €
6.150.VA.F-CO2.K	150			6"	607	55,0	3.195,00 €
6.200.VA.F-CO2.K	200	8"	942	82,0	4.849,00 €		

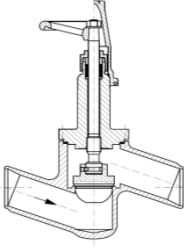
T5VA.F.L-CO2		absperrentil, Durchgang	Anschluss		Kvs	Gewicht	Preis	
		Shut Off Valve, Globe	Connection		Kvs	Weight	Price	
		Artikel-Nr. / Article-No.	DN	Inch	[m³/h]	[kg]	[EUR]	
		Oberteil geflanscht Für trockenes CO ₂ Verlängertes Oberteil Bolted bonnet For dry CO ₂ Extended bonnet		5.015.VA.F.L-CO2.K	15	1/2"	3,1	1,8
5.020.VA.F.L-CO2.K	20			3/4"	6,1	1,9	336,00 €	
5.025.VA.F.L-CO2.K	25			1"	10,0	3,4	449,00 €	
5.032.VA.F.L-CO2.K	32			1-1/4"	15,0	3,7	515,00 €	
5.040.VA.F.L-CO2.K	40			1-1/2"	23,3	5,2	695,00 €	
5.050.VA.F.L-CO2.K	50			2"	38,1	6,4	950,00 €	
5.065.VA.F.L-CO2.K	65			2-1/2"	69,6	22,0	2.045,00 €	
5.080.VA.F.L-CO2.K	80			3"	100	27,0	2.114,00 €	
5.100.VA.F.L-CO2.K	100			4"	159	32,0	2.239,00 €	

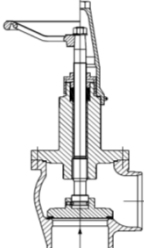
T6VA.F.L-CO2		Absperrentil, Eck	Anschluss		Kvs	Gewicht	Preis	
		Shut Off Valve, Angle	Connection		Kvs	Weight	Price	
		Artikel-Nr. / Article-No.	DN	Inch	[m³/h]	[kg]	[EUR]	
		Oberteil geflanscht Für trockenes CO ₂ Verlängertes Oberteil Bolted bonnet For dry CO ₂ Extended bonnet		6.015.VA.F.L-CO2.K	15	1/2"	3,6	1,5
6.020.VA.F.L-CO2.K	20			3/4"	8,0	1,7	332,00 €	
6.025.VA.F.L-CO2.K	25			1"	15,6	3,0	442,00 €	
6.032.VA.F.L-CO2.K	32			1-1/4"	28,4	3,5	500,00 €	
6.040.VA.F.L-CO2.K	40			1-1/2"	28,5	4,1	577,00 €	
6.050.VA.F.L-CO2.K	50			2"	53,7	5,4	753,00 €	
6.065.VA.F.L-CO2.K	65			2-1/2"	84	16,7	1.667,00 €	
6.080.VA.F.L-CO2.K	80			3"	149	20,2	1.902,00 €	
6.100.VA.F.L-CO2.K	100			4"	218	24,0	1.974,00 €	

Kugelventile Edelstahl

Ball Valves Stainless Steel

handbetätigt, aus Edelstahl, PN40, mit Handhebel, auch für CO2 geeignet
manual actuated, made of stainless steel, PN40, with lever, also suitable for CO2

T42VA		Kugelventil	Sitz	Anschluss		Kvs	Gewicht	Preis
		Ball Valve	Seat	Connection		Kvs	Weight	Price
		Artikel-Nr. / Article-No.	[mm]	DN	Inch	[m³/h]	[kg]	[EUR]
Standard Mit Anschweißenden Standard With butt weld ends ISO	42.015.VA	11,1	15	1/2"	8	0,6	299,00 €	
	42.020.VA	14,2	20	3/4"	13	0,9	349,00 €	
	42.025.VA	20,6	25	1"	30	1,3	411,00 €	
	42.032.VA	25,4	32	1-1/4"	48	1,9	482,00 €	
	42.040.VA	31,7	40	1-1/2"	80	2,9	527,00 €	
	42.050.VA	38,0	50	2"	120	4,0	636,00 €	
	42.065.VA	50,0	65	2-1/2"	250	6,7	1.051,00 €	
	42.080.VA	62,0	80	3"	470	13,0	1.957,00 €	
	42.100.VA	82,4	100	4"	700	23,0	2.878,00 €	
	42.125.VA	100,0	125	5"	1250	37,0	4.777,00 €	
	42.150.VA	100,0	150	6"	1250	40,0	4.975,00 €	

T42VA.L		Kugelventil	Sitz	Anschluss		Kvs	Gewicht	Preis
		Ball Valve	Seat	Connection		Kvs	Weight	Price
		Artikel-Nr. / Article-No.	[mm]	DN	Inch	[m³/h]	[kg]	[EUR]
Mit Isolierverlängerung Mit Anschweißenden With Bonnet Extension With butt weld ends ISO	42.015.VA.L	11,1	15	1/2"	8	1,6	559,00 €	
	42.020.VA.L	14,2	20	3/4"	13	1,9	611,00 €	
	42.025.VA.L	20,6	25	1"	30	2,5	727,00 €	
	42.032.VA.L	25,4	32	1-1/4"	48	3,1	796,00 €	
	42.040.VA.L	31,7	40	1-1/2"	80	4,6	900,00 €	
	42.050.VA.L	38,0	50	2"	120	5,7	1.008,00 €	
	42.065.VA.L	50,0	65	2-1/2"	250	9,8	1.697,00 €	
	42.080.VA.L	62,0	80	3"	470	16,0	2.740,00 €	
	42.100.VA.L	82,4	100	4"	700	29,0	3.876,00 €	
	42.125.VA.L	100,0	125	5"	1250	43,0	5.774,00 €	
	42.150.VA.L	100,0	150	6"	1250	46,0	5.972,00 €	

T43VA		Kugelventil	Sitz	Anschluss		Kvs	Gewicht	Preis
		Ball Valve	Seat	Connection		Kvs	Weight	Price
		Artikel-Nr. / Article-No.	[mm]	DN	Inch	[m³/h]	[kg]	[EUR]
Flanschanschluß DIN2634 mit Nut EN1092-1 "D" With Flanged Connection DIN2634 with groove EN1092-1 "D"	43.015.VA	11,1	15	1/2"	8	2,2	500,00 €	
	43.020.VA	14,2	20	3/4"	13	3,1	549,00 €	
	43.025.VA	20,6	25	1"	30	3,9	636,00 €	
	43.032.VA	25,4	32	1-1/4"	48	6,1	739,00 €	
	43.040.VA	31,7	40	1-1/2"	80	7,4	903,00 €	
	43.050.VA	38,0	50	2"	120	10,0	1.127,00 €	
	43.065.VA	50,0	65	2-1/2"	250	16,0	1.819,00 €	
	43.080.VA	62,0	80	3"	470	26,0	3.034,00 €	
	43.100.VA	82,4	100	4"	700	34,0	4.346,00 €	
	43.125.VA	100,0	125	5"	1250	47,0	7.443,00 €	
	43.150.VA	100,0	150	6"	1250	56,0	8.823,00 €	

T43VA.L		Kugelventil	Sitz	Anschluss		Kvs	Gewicht	Preis
		Ball Valve	Seat	Connection		Kvs	Weight	Price
		Artikel-Nr. / Article-No.	[mm]	DN	Inch	[m³/h]	[kg]	[EUR]
mit Isolierverlängerung Flanschanschluß DIN2634 mit Nut EN1092-1 "D" with extended bonnet With Flanged Connection DIN2634 with groove EN1092-1 "D"	43.015.VA.L	11,1	15	1/2"	8	3,2	761,00 €	
	43.020.VA.L	14,2	20	3/4"	13	4,1	810,00 €	
	43.025.VA.L	20,6	25	1"	30	5,1	951,00 €	
	43.032.VA.L	25,4	32	1-1/4"	48	7,3	1.052,00 €	
	43.040.VA.L	31,7	40	1-1/2"	80	9,1	1.277,00 €	
	43.050.VA.L	38,0	50	2"	120	12,0	1.501,00 €	
	43.065.VA.L	50,0	65	2-1/2"	250	20,0	2.465,00 €	
	43.080.VA.L	62,0	80	3"	470	29,0	3.816,00 €	
	43.100.VA.L	82,4	100	4"	700	40,0	5.345,00 €	
	43.125.VA.L	100,0	125	5"	1250	53,0	8.440,00 €	
	43.150.VA.L	100,0	150	6"	1250	62,0	9.823,00 €	

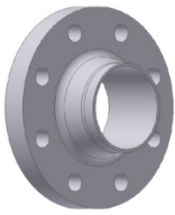
Gegenflansche / Counterflanges		Flansche (2 werden benötigt)		Anschluss		Gewicht	Preis
		Flange (you need 2 pcs.)		Connection		Weight	Price
		Artikel-Nr. / Article-No.		DN	Inch	[kg]	[EUR]
 Edelstahl, PN25/40 Schweißenden DIN2634 mit Feder EN1092-1 "C" mit Schrauben, Muttern und Dichtungen Stainless Steel, PN25/40 ISO Butt Weld Ends DIN2634 with tongue EN1092-1 "C" with bolts, nuts and gasket	FLADINF.015.VA.SMD		15	1/2"		1,8	144,00 €
	FLADINF.020.VA.SMD		20	3/4"		2,5	160,00 €
	FLADINF.025.VA.SMD		25	1"		2,9	162,00 €
	FLADINF.032.VA.SMD		32	1-1/4"		4,1	190,00 €
	FLADINF.040.VA.SMD		40	1-1/2"		4,8	199,00 €
	FLADINF.050.VA.SMD		50	2"		6,1	221,00 €
	FLADINF.065.VA.SMD		65	2-1/2"		9,0	302,00 €
	FLADINF.080.VA.SMD		80	3"		11,0	337,00 €
	FLADINF.100.VA.SMD		100	4"		16,5	507,00 €
	FLADINF.125.VA.SMD		125	5"		23,0	795,00 €
	FLADINF.150.VA.SMD		150	6"		28,5	985,00 €

Kugelventile VA mit Antrieb

Ball Valves SS with Actuator

mit pneumatischer Antrieb, 3/2-Wege-Luftmagnetventil, 230V/50Hz, Endlagenschalter, aus Edelstahl, PN40
with pneumatic actuator, 3/2-way-solenoid-valve, 230V/50Hz, limit switches, made of stainless steel, PN40

T420VA		Kugelventil	Sitz	Anschluss		Kvs	Gewicht	Preis
		Ball Valve	Seat	Connection		Kvs	Weight	Price
		Artikel-Nr. / Article-No.	[mm]	DN	Inch	[m³/h]	[kg]	[EUR]
Standard Mit Anschweißen Standard With butt weld ends ISO	420.015.VA	11,1	15	1/2"		8	4,8	1.635,00 €
	420.020.VA	14,2	20	3/4"		13	5,0	1.688,00 €
	420.025.VA	20,6	25	1"		30	6,6	1.945,00 €
	420.032.VA	25,4	32	1-1/4"		48	7,9	2.140,00 €
	420.040.VA	31,7	40	1-1/2"		80	11,0	2.311,00 €
	420.050.VA	38,0	50	2"		120	20,0	2.563,00 €
	420.065.VA	50,0	65	2-1/2"		250	21,0	3.647,00 €
	420.080.VA	62,0	80	3"		470	39,0	5.160,00 €
	420.100.VA	82,4	100	4"		700	67,0	6.834,00 €
	420.125.VA	100,0	125	5"		1250	99,0	9.638,00 €
420.150.VA	100,0	150	6"		1250	105,0	9.871,00 €	

T420VA.H		Kugelventil	Sitz	Anschluss		Kvs	Gewicht	Preis
		Ball Valve	Seat	Connection		Kvs	Weight	Price
		Artikel-Nr. / Article-No.	[mm]	DN	Inch	[m³/h]	[kg]	[EUR]
Mit Handnotbetätigung Mit Anschweißen with manual override With butt weld ends ISO	420.015.VA.H	11,1	15	1/2"		8	6,3	2.789,00 €
	420.020.VA.H	14,2	20	3/4"		13	6,5	2.840,00 €
	420.025.VA.H	20,6	25	1"		30	8,3	3.097,00 €
	420.032.VA.H	25,4	32	1-1/4"		48	9,4	3.293,00 €
	420.040.VA.H	31,7	40	1-1/2"		80	16,0	3.463,00 €
	420.050.VA.H	38,0	50	2"		120	24,0	3.717,00 €
	420.065.VA.H	50,0	65	2-1/2"		250	25,0	4.799,00 €
	420.080.VA.H	62,0	80	3"		470	49,0	6.569,00 €
	420.100.VA.H	82,4	100	4"		700	77,0	8.244,00 €
	420.125.VA.H	100,0	125	5"		1250	109,0	11.045,00 €
420.150.VA.H	100,0	150	6"		1250	116,0	11.277,00 €	

T430VA		Kugelventil	Sitz	Anschluss		Kvs	Gewicht	Preis
		Ball Valve	Seat	Connection		Kvs	Weight	Price
		Artikel-Nr. / Article-No.	[mm]	DN	Inch	[m³/h]	[kg]	[EUR]
Flanschschluß DIN2634 mit Nut EN1092-1 "D" With Flanged Connection DIN2634 with groove EN1092-1 "D"	430.015.VA	11,1	15	1/2"		8	6,3	1.837,00 €
	430.020.VA	14,2	20	3/4"		13	7,0	1.892,00 €
	430.025.VA	20,6	25	1"		30	9,5	2.168,00 €
	430.032.VA	25,4	32	1-1/4"		48	11,6	2.399,00 €
	430.040.VA	31,7	40	1-1/2"		80	15,0	2.617,00 €
	430.050.VA	38,0	50	2"		120	26,0	2.973,00 €
	430.065.VA	50,0	65	2-1/2"		250	30,0	4.276,00 €
	430.080.VA	62,0	80	3"		470	51,0	5.987,00 €
	430.100.VA	82,4	100	4"		700	80,0	7.928,00 €
	430.125.VA	100,0	125	5"		1250	114,0	11.672,00 €
430.150.VA	100,0	150	6"		1250	130,0	13.058,00 €	

T430VA.H		Kugelventil	Sitz	Anschluss		Kvs	Gewicht	Preis
		Ball Valve	Seat	Connection		Kvs	Weight	Price
		Artikel-Nr. / Article-No.	[mm]	DN	Inch	[m³/h]	[kg]	[EUR]
Handnotbetätigung Flanschschluß DIN2634 mit Nut EN1092-1 "D" Manual override With Flanged Connection DIN2634 with groove EN1092-1 "D"	430.015.VA.H	11,1	15	1/2"		8	7,9	2.990,00 €
	430.020.VA.H	14,2	20	3/4"		13	8,5	3.044,00 €
	430.025.VA.H	20,6	25	1"		30	10,9	3.320,00 €
	430.032.VA.H	25,4	32	1-1/4"		48	13,1	3.554,00 €
	430.040.VA.H	31,7	40	1-1/2"		80	20,0	3.773,00 €
	430.050.VA.H	38,0	50	2"		120	31,0	4.126,00 €
	430.065.VA.H	50,0	65	2-1/2"		250	34,0	5.430,00 €
	430.080.VA.H	62,0	80	3"		470	51,0	7.395,00 €
	430.100.VA.H	82,4	100	4"		700	90,0	9.334,00 €
	430.125.VA.H	100,0	125	5"		1250	124,0	13.079,00 €
430.150.VA.H	100,0	150	8"		1250	140,0	14.466,00 €	

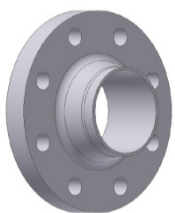
Gegenflansche / Counterflanges		Flansche (2 werden benötigt)		Anschluss		Gewicht	Preis
		Flange (you need 2 pcs.)		Connection		Weight	Price
		Artikel-Nr. / Article-No.		DN	Inch	[kg]	[EUR]
 Edelstahl, PN25/40 Schweißenden DIN2634 mit Feder EN1092-1 "C" mit Schrauben, Muttern und Dichtungen Stainless Steel, PN25/40 ISO Butt Weld Ends DIN2634 with tongue EN1092-1 "C" with bolts, nuts and gasket	FLADINF.015.VA.SMD		15	1/2"		1,8	144,00 €
	FLADINF.020.VA.SMD		20	3/4"		2,5	160,00 €
	FLADINF.025.VA.SMD		25	1"		2,9	162,00 €
	FLADINF.032.VA.SMD		32	1-1/4"		4,1	190,00 €
	FLADINF.040.VA.SMD		40	1-1/2"		4,8	199,00 €
	FLADINF.050.VA.SMD		50	2"		6,1	221,00 €
	FLADINF.065.VA.SMD		65	2-1/2"		9,0	302,00 €
	FLADINF.080.VA.SMD		80	3"		11,0	337,00 €
	FLADINF.100.VA.SMD		100	4"		16,5	507,00 €
	FLADINF.125.VA.SMD		125	5"		23,0	795,00 €
FLADINF.150.VA.SMD		150	6"		28,5	985,00 €	

Kugelventile VA mit Antrieb
Ball Valves SS with Actuator

 mit elektrischen Antrieb, 230V/50Hz, Endlagenschalter, aus Edelstahl, PN40
 with electric actuator, 230V/50Hz, limit switches, made of stainless steel, PN40

T620VA.H		Kugelventil	Sitz	Anschluss		Kvs	Gewicht	Preis
		Ball Valve	Seat	Connection		Kvs	Weight	Price
		Artikel-Nr. / Article-No.	[mm]	DN	Inch	[m ³ /h]	[kg]	[EUR]
Mit Handnotbetätigung Mit Anschweißenden with manual override With butt weld ends ISO	620.015.VA.H	11,1	15	1/2"	8	9,0	2.346,00 €	
	620.020.VA.H	14,2	20	3/4"	13	10,0	2.399,00 €	
	620.025.VA.H	20,6	25	1"	30	11,0	2.516,00 €	
	620.032.VA.H	25,4	32	1-1/4"	48	12,0	2.581,00 €	
	620.040.VA.H	31,7	40	1-1/2"	80	12,0	3.093,00 €	
	620.050.VA.H	38,0	50	2"	120	13,0	3.210,00 €	
	620.065.VA.H	50,0	65	2-1/2"	250	17,0	4.164,00 €	
	620.080.VA.H	62,0	80	3"	470	33,0	5.876,00 €	
	620.100.VA.H	82,4	100	4"	700	45,0	7.473,00 €	
	620.125.VA.H	100,0	125	5"	1250	58,0	9.944,00 €	
620.150.VA.H	100,0	150	6"	1250	64,0	10.171,00 €		

T630H		Kugelventil	Sitz	Connection		Kvs	Weight	Price
		Ball Valve	Seat	Connection		Kvs	Weight	Price
		Article-No.	[mm]	DN	Inch	[m ³ /h]	[kg]	[EUR]
Handnotbetätigung Flanschschluß DIN2634 mit Nut EN1092-1 "D" Manual override With Flanged Connection DIN2634 with groove EN1092-1 "D"	630.015.VA.H	11,1	15	1/2"	8	11,0	2.595,00 €	
	630.020.VA.H	14,2	20	3/4"	13	12,0	2.649,00 €	
	630.025.VA.H	20,6	25	1"	30	15,0	2.790,00 €	
	630.032.VA.H	25,4	32	1-1/4"	48	16,0	2.891,00 €	
	630.040.VA.H	31,7	40	1-1/2"	80	16,0	3.456,00 €	
	630.050.VA.H	38,0	50	2"	120	19,0	3.683,00 €	
	630.065.VA.H	50,0	65	2-1/2"	250	26,0	4.874,00 €	
	630.080.VA.H	62,0	80	3"	470	44,0	6.815,00 €	
	630.100.VA.H	82,4	100	4"	700	58,0	8.710,00 €	
	630.125.VA.H	100,0	125	5"	1250	73,0	12.172,00 €	
630.150.VA.H	100,0	150	6"	1250	89,0	13.558,00 €		

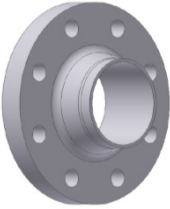
Gegenflansche / Counterflanges		Flansche (2 werden benötigt)		Anschluss		Gewicht	Preis
		Flange (you need 2 pcs.)		Connection		Weight	Price
		Artikel-Nr. / Article-No.		DN	Inch	[kg]	[EUR]
 Edelstahl, PN25/40 Schweißenden DIN2634 mit Feder EN1092-1 "C" mit Schrauben, Muttern und Dichtungen Stainless Steel, PN25/40 ISO Butt Weld Ends DIN2634 with tongue EN1092-1 "C" with bolts, nuts and gasket	FLADINF.015.VA.SMD		15	1/2"		1,8	144,00 €
	FLADINF.020.VA.SMD		20	3/4"		2,5	160,00 €
	FLADINF.025.VA.SMD		25	1"		2,9	162,00 €
	FLADINF.032.VA.SMD		32	1-1/4"		4,1	190,00 €
	FLADINF.040.VA.SMD		40	1-1/2"		4,8	199,00 €
	FLADINF.050.VA.SMD		50	2"		6,1	221,00 €
	FLADINF.065.VA.SMD		65	2-1/2"		9,0	302,00 €
	FLADINF.080.VA.SMD		80	3"		11,0	337,00 €
	FLADINF.100.VA.SMD		100	4"		16,5	507,00 €
	FLADINF.125.VA.SMD		125	5"		23,0	795,00 €
FLADINF.150.VA.SMD		150	6"		28,5	985,00 €	

Absperrklappen VA

Butterfly Valves SS

handbetätigt, aus Edelstahl, PN25, mit Handhebel, auch für CO2 geeignet
manual actuated, made of stainless steel, PN25, with lever, also suitable for CO2

Gegenflansche siehe nächste Seite
Counterflanges see next page

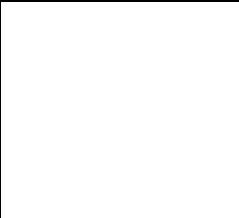
T53VA		Absperrklappe	Sitz	Anschluss		Kvs	Gewicht	Preis
		Butterfly Valve	Seat	Connection		Kvs	Weight	Price
		Article-No.	[mm]	DN	Inch	[m³/h]	[kg]	[EUR]
 <p>Flanschschluß DIN2634 mit Nut EN1092-1 "D" With Flanged Connection DIN2634 with groove EN1092-1 "D"</p>	53.050.VA	40,0	50	2"	115	3,6	2.767,00 €	
	53.065.VA	51,0	65	2-1/2"	210	5,0	2.932,00 €	
	53.080.VA	66,0	80	3"	320	5,4	3.036,00 €	
	53.100.VA	90,0	100	4"	500	8,9	3.866,00 €	
	53.125.VA	113,0	125	5"	820	10,5	4.277,00 €	
	53.150.VA	141,0	150	6"	1200	13,5	5.253,00 €	
	53.200.VA	189,0	200	8"	2300	24,0	6.693,00 €	
	53.250.VA	236,0	250	10"	3600	40,4	11.653,00 €	
	53.300.VA	282,0	300	12"	5200	54,6	15.980,00 €	
53.350.VA	326,0	350	14"	7300	74,4	19.657,00 €		

Absperrklappen VA mit Antrieb

Butterfly Valves SS with Actuator

Standard: mit pneumatischer Antrieb, 3/2-Wege-Luftmagnetventil, 230V/50Hz, Endlagenschalter, aus Edelstahl, PN25
Standard: with pneumatic actuator, 3/2-way-solenoid-valve, 230V/50Hz, limit switches, made of stainless steel, PN25

Gegenflansche siehe nächste Seite
Counterflanges see next page

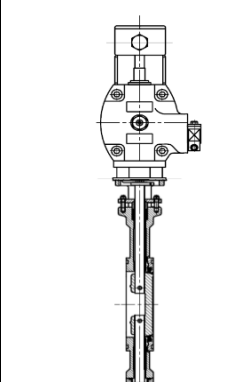
T530VA		Absperrklappe	Sitz	Anschluss		Kvs	Gewicht	Preis
		Butterfly Valve	Seat	Connection		Kvs	Weight	Price
		Artikel-Nr. / Article-No.	[mm]	DN	Inch	[m³/h]	[kg]	[EUR]
 <p>Flanschschluß DIN2634 mit Nut EN1092-1 "D" With Flanged Connection DIN2634 with groove EN1092-1 "D"</p>	530.050.VA	40,0	50	2"	115	9,0	4.145,00 €	
	530.065.VA	51,0	65	2-1/2"	210	11,0	4.459,00 €	
	530.080.VA	66,0	80	3"	320	11,0	4.630,00 €	
	530.100.VA	90,0	100	4"	500	19,0	5.939,00 €	
	530.125.VA	113,0	125	5"	820	24,0	6.838,00 €	
	530.150.VA	141,0	150	6"	1200	26,0	7.976,00 €	
	530.200.VA	189,0	200	8"	2300	46,0	10.228,00 €	
	530.250.VA	236,0	250	10"	3600	96,0	17.962,00 €	
	530.300.VA	282,0	300	12"	5200	133,0	27.382,00 €	
	530.350.VA	326,0	350	14"	7300	208,0	34.733,00 €	

T530VA.H

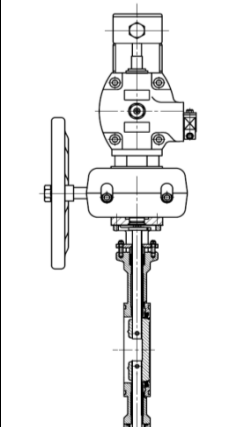
T530VA.H		Absperrklappe	Sitz	Anschluss		Kvs	Gewicht	Preis
		Butterfly Valve	Seat	Connection		Kvs	Weight	Price
		Artikel-Nr. / Article-No.	[mm]	DN	Inch	[m³/h]	[kg]	[EUR]
 <p>Handnotbetätigung Flanschschluß DIN2634 mit Nut EN1092-1 "D" Manual override With Flanged Connection DIN2634 with groove EN1092-1 "D"</p>	530.050.VA.H	40,0	50	2"	115	18,0	5.241,00 €	
	530.065.VA.H	51,0	65	2-1/2"	210	19,0	5.557,00 €	
	530.080.VA.H	66,0	80	3"	320	20,0	5.726,00 €	
	530.100.VA.H	90,0	100	4"	500	29,0	7.280,00 €	
	530.125.VA.H	113,0	125	5"	820	34,0	8.179,00 €	
	530.150.VA.H	141,0	150	6"	1200	36,0	9.319,00 €	
	530.200.VA.H	189,0	200	8"	2300	56,0	11.570,00 €	
	530.250.VA.H	236,0	250	10"	3600	110,0	19.642,00 €	
	530.300.VA.H	282,0	300	12"	5200	147,0	29.058,00 €	

Gegenflansche finden sie auf der nächsten Seite!
Counterflanges you will find on the next page!

Absperklappen VA mit Antrieb

Butterfly Valves SS with Actuator

mit elektrischen Antrieb, 230V/50Hz, Endlagenschalter, aus Edelstahl, PN25
with electric actuator, 230V/50Hz, limit switches, made of stainless steel, PN25

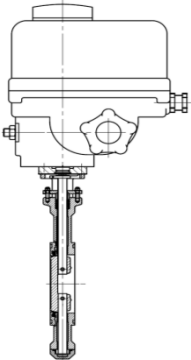
T730VA.H		Absperklappe	Sitz	Anschluss		Kvs	Gewicht	Preis
		Butterfly Valve	Seat	Connection		Kvs	Weight	Price
 <p>Handnotbetätigung Flanschanschluß DIN2634 mit Nut EN1092-1 "D" Manual override With Flanged Connection DIN2634 with groove EN1092-1 "D"</p>		Artikel-Nr. / Article-No.	[mm]	DN	Inch	[m³/h]	[kg]	[EUR]
		730.050.VA.H	40,0	50	2"	115	9,0	4.639,00 €
		730.065.VA.H	51,0	65	2-1/2"	210	11,0	4.808,00 €
		730.080.VA.H	66,0	80	3"	320	11,0	5.261,00 €
		730.100.VA.H	90,0	100	4"	500	15,0	6.342,00 €
		730.125.VA.H	113,0	125	5"	820	18,0	7.444,00 €
		730.150.VA.H	141,0	150	6"	1200	29,0	8.424,00 €
		730.200.VA.H	189,0	200	8"	2300	40,0	10.189,00 €
		730.250.VA.H	236,0	250	10"	3600	59,0	15.351,00 €
		730.300.VA.H	282,0	300	12"	5200	75,0	19.901,00 €

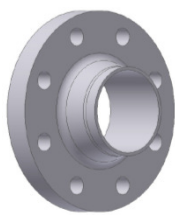
Gegenflansche / Counterflanges		für Absperklappe			Gewicht	Preis
		for Butterflyvalve			Weight	Price
 <p>Gegenflansch Edelstahl, PN25/40 Schweißenden DIN2634 mit Feder EN1092-1 "C" Counterflange Stainless Steel, PN25 ISO Butt Weld Ends DIN2634 with tongue EN1092-1 "C"</p>		Artikel-Nr. / Article-No.	DN	Inch	[kg]	[EUR]
		FLADINF.050.VA	50	2"		198,00 €
		FLADINF.065.VA	65	2-1/2"		263,00 €
		FLADINF.080.VA	80	3"		298,00 €
		FLADINF.100.VA	100	4"		423,00 €
		FLADINF.125.VA	125	5"		579,00 €
		FLADINF.150.VA	150	6"		792,00 €
		FLADINF.200.VA	200	8"		1.058,00 €
		FLADINF.250.VA	250	10"		#NV
		FLADINF.300.VA	300	12"		#NV
<p>Flanschdichtung Gasket Flange</p>		DI.FLANUT.050	50	2"		13,00 €
		DI.FLANUT.065	65	2-1/2"		15,00 €
		DI.FLANUT.080	80	3"		18,00 €
		DI.FLANUT.100	100	4"		26,00 €
		DI.FLANUT.125	125	5"		32,00 €
		DI.FLANUT.150	150	6"		37,00 €
		DI.FLANUT.200	200	8"		59,00 €
		DI.FLANUT.250	250	10"		96,00 €
DI.FLANUT.300	300	12"		105,00 €		
<p>Schrauben/Mutternsatz Bolts/Nuts Kit</p>		SM.050.T53	50	2"		43,00 €
		SM.065.T53	65	2-1/2"		43,00 €
		SM.080.T53	80	3"		87,00 €
		SM.100.T53	100	4"		184,00 €
		SM.125.T53	125	5"		281,00 €
		SM.150.T53	150	6"		293,00 €
		SM.200.T53	200	8"		475,00 €
		SM.250.T53	250	10"		948,00 €
SM.300.T53	300	12"		1.261,00 €		

Regelventile Edelstahl Regulating Valve Stainless Steel

Standard: handbetätigt, aus Edelstahl, mit ISO Anschweißenden, Kappe, PN25
Standard: manual actuated, made of stainless steel, with butt weld ends ISO, cap, PN25
Alternative: Anschweißenden mit Schweißfase nach ANSI, Schedule, mit Handrad
Alternative: butt weld ends according ANSI, Schedule, with handwheel

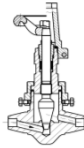
T5VA-R		Regelventil, Durchgang	Anschluss		Kvs	Gewicht	Preis
		Regulating Valve, Globe	Connection		Kvs	Weight	Price
		Artikel-Nr. / Article-No.	DN	Inch	[m³/h]	[kg]	[EUR]
		Oberteil geschraubt Screwed bonnet		5.006.VA-R.K	6	1/4"	0,70
5.008.VA-R.K	8			5/16"	1,36	0,9	on request
5.012.VA-R.K	12			1/2"	2,15	0,9	on request

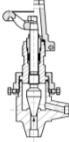
T6VA-R		Regelventil, Eck	Anschluss		Kvs	Gewicht	Preis
		Regulating Valve, Angle	Connection		Kvs	Weight	Price
		Artikel-Nr. / Article-No.	DN	Inch	[m³/h]	[kg]	[EUR]
		Oberteil geschraubt Screwed bonnet		6.006.VA-R.K	6	1/4"	0,94
6.008.VA-R.K	8			5/16"	2,12	0,8	on request
6.012.VA-R.K	12			1/2"	3,60	0,8	on request

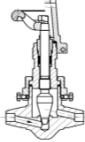
T5VA-R.x		Nadelventil, Durchgang	Anschluss		Kvs	Gewicht	Preis
		Needle Valve, Globe	Connection		Kvs	Weight	Price
		Artikel-Nr. / Article-No.	DN	Inch	[m³/h]	[kg]	[EUR]
		Oberteil geschraubt Screwed bonnet		5.006.VA-R.3.K	15	1/2"	0,24
5.006.VA-R.5.K	15			1/2"	0,53	0,6	274,00 €
5.006.VA-R.7.K	15			1/2"	0,78	0,6	274,00 €

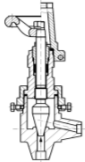
T6VA-R.x		Nadelventil, Eck	Anschluss		Kvs	Gewicht	Preis
		Needle Valve, Angle	Connection		Kvs	Weight	Price
		Artikel-Nr. / Article-No.	DN	Inch	[m³/h]	[kg]	[EUR]
		Oberteil geschraubt Screwed bonnet		6.006.VA-R.3.K	15	1/2"	0,28
6.006.VA-R.5.K	15			1/2"	0,53	0,5	274,00 €
6.006.VA-R.7.K	15			1/2"	0,83	0,5	274,00 €

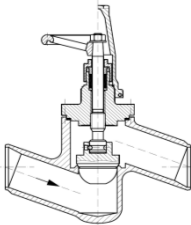
T5VA.F-R		Regelventil, Durchgang	Anschluss		Kvs	Gewicht	Preis
		Regulating Valve, Globe	Connection		Kvs	Weight	Price
		Artikel-Nr. / Article-No.	DN	Inch	[m³/h]	[kg]	[EUR]
		Oberteil geflanscht Bolted bonnet		5.015.VA.F-R.K	15	1/2"	3,8
5.020.VA.F-R.K	20			3/4"	6,1	1,7	299,00 €
5.025.VA.F-R.K	25			1"	8,8	3,0	396,00 €
5.032.VA.F-R.K	32			1-1/4"	12,7	3,5	459,00 €
5.040.VA.F-R.K	40			1-1/2"	24,0	4,8	617,00 €
5.050.VA.F-R.K	50			2"	34,8	6,6	796,00 €
5.065.VA.F-R.K	65			2-1/2"	73,4	16,0	1.726,00 €
5.080.VA.F-R.K	80			3"	96,1	23,8	1.814,00 €
5.100.VA.F-R.K	100			4"	166,7	32,0	1.961,00 €
5.125.VA.F-R.K	125			5"	252,6	63,0	3.464,00 €
5.150.VA.F-R.K	150	6"	397,0	108,0	3.749,00 €		
5.200.VA.F-R.K	200	8"	630,0	174,0	7.250,00 €		

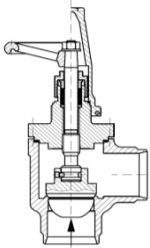
T6VA.F-R		Regelventil, Eck	Anschluss		Kvs	Gewicht	Preis
		Regulating Valve, Angle	Connection		Kvs	Weight	Price
		Artikel-Nr. / Article-No.	DN	Inch	[m³/h]	[kg]	[EUR]
		Oberteil geflanscht Bolted bonnet		6.015.VA.F-R.K	15	1/2"	5,3
6.020.VA.F-R.K	20			3/4"	8,9	1,4	293,00 €
6.025.VA.F-R.K	25			1"	14,0	2,7	386,00 €
6.032.VA.F-R.K	32			1-1/4"	23,8	2,9	446,00 €
6.040.VA.F-R.K	40			1-1/2"	37,8	4,1	499,00 €
6.050.VA.F-R.K	50			2"	55,4	5,3	601,00 €
6.065.VA.F-R.K	65			2-1/2"	88,1	14,4	1.347,00 €
6.080.VA.F-R.K	80			3"	115,3	15,3	1.602,00 €
6.100.VA.F-R.K	100			4"	200,0	21,0	1.692,00 €
6.125.VA.F-R.K	125			5"	303,1	48,0	3.089,00 €
6.150.VA.F-R.K	150			6"	476,4	86,0	3.271,00 €
6.200.VA.F-R.K	200			8"	756,0	117,0	4.925,00 €

Regelventile Edelstahl

Regulating Valve Stainless Steel

Standard: handbetätigt, aus Edelstahl, mit ISO Anschweißenden, Kappe, PN25
Standard: manual actuated, made of stainless steel, with butt weld ends ISO, cap, PN25
Alternative: Anschweißenden mit Schweißfase nach ANSI, Schedule, mit Handrad
Alternative: butt weld ends according ANSI, Schedule, with handwheel

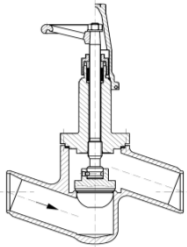
T5VA.F.L-R		Regelventil, Durchgang	Anschluss		Kvs	Gewicht	Preis
		Regulating Valve, Globe	Connection		Kvs	Weight	Price
		Artikel-Nr. / Article-No.	DN	Inch	[m³/h]	[kg]	[EUR]
		Verlängertes Oberteil Extended bonnet		5.015.VA.F.L-R.K	15	1/2"	3,8
		5.020.VA.F.L-R.K	20	3/4"	6,1	2,0	328,00 €
		5.025.VA.F.L-R.K	25	1"	8,8	3,5	437,00 €
		5.032.VA.F.L-R.K	32	1-1/4"	12,7	3,9	498,00 €
		5.040.VA.F.L-R.K	40	1-1/2"	24,0	5,3	674,00 €
		5.050.VA.F.L-R.K	50	2"	34,8	7,2	933,00 €
		5.065.VA.F.L-R.K	65	2-1/2"	73,4	18,9	2.022,00 €
		5.080.VA.F.L-R.K	80	3"	96,1	28,6	2.111,00 €
		5.100.VA.F.L-R.K	100	4"	166,7	37,0	2.257,00 €

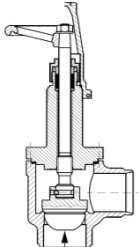
T6VA.F.L-R		Regelventil, Eck	Anschluss		Kvs	Gewicht	Preis
		Regulating Valve, Angle	Connection		Kvs	Weight	Price
		Artikel-Nr. / Article-No.	DN	Inch	[m³/h]	[kg]	[EUR]
		Verlängertes Oberteil Extended bonnet		6.015.VA.F.L-R.K	15	1/2"	5,3
		6.020.VA.F.L-R.K	20	3/4"	8,9	1,7	324,00 €
		6.025.VA.F.L-R.K	25	1"	14,0	3,0	427,00 €
		6.032.VA.F.L-R.K	32	1-1/4"	23,8	3,5	488,00 €
		6.040.VA.F.L-R.K	40	1-1/2"	37,8	4,4	558,00 €
		6.050.VA.F.L-R.K	50	2"	55,4	5,8	736,00 €
		6.065.VA.F.L-R.K	65	2-1/2"	88,1	21,0	1.642,00 €
		6.080.VA.F.L-R.K	80	3"	115,3	21,8	1.899,00 €
		6.100.VA.F.L-R.K	100	4"	200,0	27,0	1.986,00 €

Regel/Absperrventile VA

Regulating /Shut-Off Valves, SS

Standard: handbetätigt, aus Stahl, mit ISO Anschweißenden, Kappe, PN25
Standard: manual actuated, made of steel, with butt weld ends ISO, cap, PN25
Alternative: Anschweißenden mit Schweißfase nach ANSI, Schedule, mit Handrad
Alternative: butt weld ends according ANSI, Schedule, with handwheel

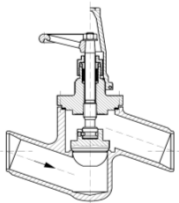
T5VA.F-R/AV		Regelventil, Durchgang	Anschluss		Kvs	Gewicht	Preis
		Regulating Valve, Globe	Connection		Kvs	Weight	Price
		Artikel-Nr. / Article-No.	DN	Inch	[m³/h]	[kg]	[EUR]
		Oberteil geflanscht Bolted bonnet		5.015.VA.F-R/AV.K	15	1/2"	3,8
		5.020.VA.F-R/AV.K	20	3/4"	6,1	1,7	276,00 €
		5.025.VA.F-R/AV.K	25	1"	8,8	3,0	396,00 €

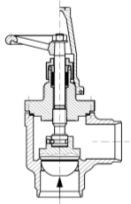
T6VA.F-R/AV		Regelventil, Eck	Anschluss		Kvs	Gewicht	Preis
		Regulating Valve, Angle	Connection		Kvs	Weight	Price
		Artikel-Nr. / Article-No.	DN	Inch	[m³/h]	[kg]	[EUR]
		Oberteil geflanscht Bolted bonnet		6.015.VA.F-R/AV.K	15	1/2"	5,3

Regelventile VA, FABA

Regulating Valves SS, Bellows

Standard: handbetätigt, aus Edelstahl, mit ISO Anschweißenden, Kappe, PN25
Standard: manual actuated, made of stainless steel, with butt weld ends ISO, cap, PN25
Alternative: Anschweißenden mit Schweißfase nach ANSI, Schedule, mit Handrad
Alternative: butt weld ends according ANSI, Schedule, with handwheel

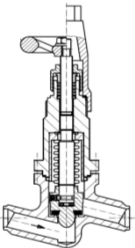
T5VA.F.FA-R		Regelventil, Durchgang	Anschluss		Kvs	Gewicht	Preis
		Regulating Valve, Globe	Connection		Kvs	Weight	Price
 <p>Spindelabdichtung: Faltenbalg Oberteil geflanscht Stem Sealing: Bellows Seal Bolted bonnet</p>		Artikel-Nr. / Article-No.	DN	Inch	[m ³ /h]	[kg]	[EUR]
		5.015.VA.F.FA-R.K	15	1/2"	3,8	1,8	836,00 €
		5.020.VA.F.FA-R.K	20	3/4"	6,1	2,1	871,00 €
		5.025.VA.F.FA-R.K	25	1"	8,8	3,6	1.142,00 €
		5.032.VA.F.FA-R.K	32	1-1/4"	12,7	4,0	1.196,00 €
		5.040.VA.F.FA-R.K	40	1-1/2"	24,0	5,6	1.547,00 €
		5.050.VA.F.FA-R.K	50	2"	34,8	8,0	1.863,00 €
		5.065.VA.F.FA-R.K	65	2-1/2"	73,4	18,2	3.191,00 €
		5.080.VA.F.FA-R.K	80	3"	96,1	26,6	3.610,00 €
		5.100.VA.F.FA-R.K	100	4"	166,7	39,0	4.294,00 €

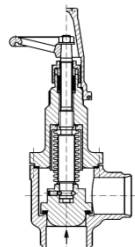
T6VA.F.FA-R		Regelventil, Eck	Anschluss		Kvs	Gewicht	Preis
		Regulating Valve, Angle	Connection		Kvs	Weight	Price
 <p>Spindelabdichtung: Faltenbalg Oberteil geflanscht Stem Sealing: Bellows Seal Bolted bonnet</p>		Artikel-Nr. / Article-No.	DN	Inch	[m ³ /h]	[kg]	[EUR]
		6.015.VA.F.FA-R.K	15	1/2"	5,3	1,6	829,00 €
		6.020.VA.F.FA-R.K	20	3/4"	8,9	1,7	865,00 €
		6.025.VA.F.FA-R.K	25	1"	14,0	3,2	1.138,00 €
		6.032.VA.F.FA-R.K	32	1-1/4"	23,8	3,7	1.191,00 €
		6.040.VA.F.FA-R.K	40	1-1/2"	37,8	5,0	1.435,00 €
		6.050.VA.F.FA-R.K	50	2"	55,4	6,3	1.746,00 €
		6.065.VA.F.FA-R.K	65	2-1/2"	88,1	21,0	2.915,00 €
		6.080.VA.F.FA-R.K	80	3"	115,3	21,9	3.263,00 €
		6.100.VA.F.FA-R.K	100	4"	200,0	27,4	3.928,00 €

Regelventile VA, CO²

Regulating Valves SS, CO²

Standard: handbetätigt, aus Edelstahl, mit ISO Anschweißenden, Kappe, PN40
Standard: manual actuated, made of stainless steel, with butt weld ends ISO, cap, PN40
Alternative: Anschweißenden mit Schweißfase nach ANSI, Schedule, mit Handrad
Alternative: butt weld ends according ANSI, Schedule, with handwheel

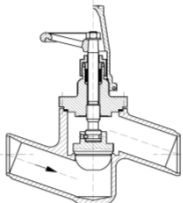
T5VA.F-CO2-R		Regelventil, Durchgang	Anschluss		Kvs	Gewicht	Preis
		Regulating Valve, Globe	Connection		Kvs	Weight	Price
		Artikel-Nr. / Article-No.	DN	Inch	[m ³ /h]	[kg]	[EUR]
		Oberteil geflanscht Für trockenes CO ₂ Bolted bonnet For dry CO ₂		5.015.VA.F-CO2-R.K	15	1/2"	3,8
5.020.VA.F-CO2-R.K	20			3/4"	6,1	1,7	305,00 €
5.025.VA.F-CO2-R.K	25			1"	8,8	3,0	409,00 €
5.032.VA.F-CO2-R.K	32			1-1/4"	12,7	3,5	470,00 €
5.040.VA.F-CO2-R.K	40			1-1/2"	24,0	4,8	634,00 €
5.050.VA.F-CO2-R.K	50			2"	34,8	6,6	816,00 €
5.065.VA.F-CO2-R.K	65			2-1/2"	73,4	16,0	1.766,00 €
5.080.VA.F-CO2-R.K	80			3"	96,1	23,8	1.856,00 €
5.100.VA.F-CO2-R.K	100			4"	166,7	32,0	2.001,00 €
5.125.VA.F-CO2-R.K	125			5"	252,6	63,0	3.525,00 €
5.150.VA.F-CO2-R.K	150	6"	397,0	108,0	3.835,00 €		

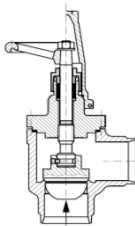
T6VA.F-CO2-R		Regelventil, Eck	Anschluss		Kvs	Gewicht	Preis	
		Regulating Valve, Angle	Connection		Kvs	Weight	Price	
		Artikel-Nr. / Article-No.	[mm]	DN	Inch	[m ³ /h]	[kg]	[EUR]
		Oberteil geflanscht Für trockenes CO ₂ Bolted bonnet For dry CO ₂		6.015.VA.F-CO2-R.K		15	1/2"	5,3
6.020.VA.F-CO2-R.K				20	3/4"	8,9	1,4	301,00 €
6.025.VA.F-CO2-R.K				25	1"	14,0	2,7	401,00 €
6.032.VA.F-CO2-R.K				32	1-1/4"	23,8	2,9	460,00 €
6.040.VA.F-CO2-R.K				40	1-1/2"	37,8	4,1	519,00 €
6.050.VA.F-CO2-R.K				50	2"	55,4	5,3	617,00 €
6.065.VA.F-CO2-R.K				65	2-1/2"	88,1	14,4	1.388,00 €
6.080.VA.F-CO2-R.K				80	3"	115,3	15,3	1.642,00 €
6.100.VA.F-CO2-R.K				100	4"	200,0	21,0	1.732,00 €
6.125.VA.F-CO2-R.K				125	5"	303,1	48,0	3.150,00 €
6.150.VA.F-CO2-R.K				150	6"	476,4	86,0	3.358,00 €

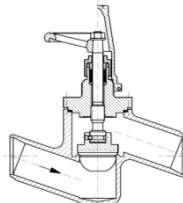
T5VA.F.L-CO2-R		Regelventil, Durchgang	Anschluss		Kvs	Gewicht	Preis
		Regulating Valve, Globe	Connection		Kvs	Weight	Price
		Artikel-Nr. / Article-No.	DN	Inch	[m ³ /h]	[kg]	[EUR]
		Oberteil geflanscht Für trockenes CO ₂ Verlängertes Oberteil Bolted bonnet For dry CO ₂ Extended bonnet		5.015.VA.F.L-CO2-R.K	15	1/2"	3,8
5.020.VA.F.L-CO2-R.K	20			3/4"	6,1	2,0	342,00 €
5.025.VA.F.L-CO2-R.K	25			1"	8,8	3,5	455,00 €
5.032.VA.F.L-CO2-R.K	32			1-1/4"	12,7	3,9	520,00 €
5.040.VA.F.L-CO2-R.K	40			1-1/2"	24,0	5,3	707,00 €
5.050.VA.F.L-CO2-R.K	50			2"	34,8	7,2	965,00 €
5.065.VA.F.L-CO2-R.K	65			2-1/2"	73,4	18,9	2.072,00 €
5.080.VA.F.L-CO2-R.K	80			3"	96,1	28,6	2.164,00 €
5.100.VA.F.L-CO2-R.K	100			4"	166,7	37,0	2.308,00 €

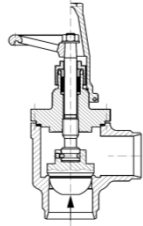
T6VA.F.L-CO2-R		Regelventil, Eck	Anschluss		Kvs	Gewicht	Preis
		Regulating Valve, Angle	Connection		Kvs	Weight	Price
		Artikel-Nr. / Article-No.	DN	Inch	[m ³ /h]	[kg]	[EUR]
		Oberteil geflanscht Für trockenes CO ₂ Verlängertes Oberteil Bolted bonnet For dry CO ₂ Extended bonnet		6.015.VA.F.L-CO2-R.K	15	1/2"	5,3
6.020.VA.F.L-CO2-R.K	20			3/4"	8,9	1,7	337,00 €
6.025.VA.F.L-CO2-R.K	25			1"	14,0	3,0	446,00 €
6.032.VA.F.L-CO2-R.K	32			1-1/4"	23,8	3,5	504,00 €
6.040.VA.F.L-CO2-R.K	40			1-1/2"	37,8	4,4	586,00 €
6.050.VA.F.L-CO2-R.K	50			2"	55,4	5,8	769,00 €
6.065.VA.F.L-CO2-R.K	65			2-1/2"	88,1	21,0	1.695,00 €
6.080.VA.F.L-CO2-R.K	80			3"	115,3	21,8	1.949,00 €
6.100.VA.F.L-CO2-R.K	100			4"	200,0	27,0	2.041,00 €

Schmutzsammler VA

Strainer SS

Standard: aus Edelstahl, PN25, mit ISO Anschweißenden, Maschenweite 0,5mm, (auch für CO2 geeignet)
Standard: made of stainless steel, PN25, with butt weld ends ISO, mesh size 0.5m, (also suitable for CO2)

Alternative: Anschweißenden mit Schweißfase nach ANSI, Schedule
Alternative: butt weld ends according ANSI, Schedule

Alternative: Maschenweite 0,1mm
Alternative: mesh size 0,1mm

Alternative: Anschweißenden mit Schweißfase nach ANSI, Schedule, mit Maschenweite 0,1mm
Alternative: butt weld ends according ANSI, Schedule, with mesh size 0,1mm

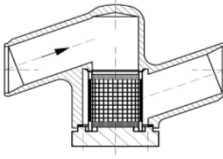
T5VA.F-SS		Schmutzsammler, Durchg.	Anschluss		Kvs	Gewicht	Preis
		Strainer, Globe	Connection		Kvs	Weight	Price
 Oberteil geflanscht Bolted bonnet		Artikel-Nr. / Article-No.	DN	Inch	[m³/h]	[kg]	[EUR]
		5.015.VA.F-SS.5	15	1/2"	5,8	1,0	249,00 €
5.020.VA.F-SS.5	20	3/4"	7,3	1,2	287,00 €		
5.025.VA.F-SS.5	25	1"	11,8	2,0	346,00 €		
5.032.VA.F-SS.5	32	1-1/4"	15,5	2,4	418,00 €		
5.040.VA.F-SS.5	40	1-1/2"	24,9	3,7	604,00 €		
5.050.VA.F-SS.5	50	2"	33,4	5,2	816,00 €		
5.065.VA.F-SS.5	65	2-1/2"	59,6	14,2	1.311,00 €		
5.080.VA.F-SS.5	80	3"	83,2	15,8	1.410,00 €		
5.100.VA.F-SS.5	100	4"	135,0	22,2	1.570,00 €		

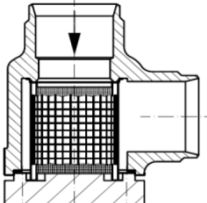
T6VA.F-SS		Schmutzsammler, Eck	Anschluss		Kvs	Gewicht	Preis
		Strainer, Angle	Connection		Kvs	Weight	Price
 Oberteil geflanscht Bolted bonnet		Artikel-Nr. / Article-No.	DN	Inch	[m³/h]	[kg]	[EUR]
		6.015.VA.F-SS.5	15	1/2"	4,9	0,8	238,00 €
6.020.VA.F-SS.5	20	3/4"	8,0	0,9	282,00 €		
6.025.VA.F-SS.5	25	1"	13,1	1,7	337,00 €		
6.032.VA.F-SS.5	32	1-1/4"	26,2	2,0	409,00 €		
6.040.VA.F-SS.5	40	1-1/2"	27,1	3,0	486,00 €		
6.050.VA.F-SS.5	50	2"	50,4	3,8	617,00 €		
6.065.VA.F-SS.5	65	2-1/2"	71,9	9,3	933,00 €		
6.080.VA.F-SS.5	80	3"	124,0	9,6	1.196,00 €		
6.100.VA.F-SS.5	100	4"	185,0	13,4	1.304,00 €		

Rückschlagventile VA

Check Valve SS

TF: Für die Flüssigkeitsleitung und Heissgas-Abtauung
TF: For liquid line and hotgas-defrosting

Standard: aus Edelstahl, PN25, mit ISO Anschweißenden
Standard: made of stainless steel, PN25, with butt weld ends ISO

Alternative: Anschweißenden mit Schweißfase nach ANSI, Schedule
Alternative: butt weld ends according ANSI, Schedule

Auslegung mit V.S.P. Valve Selection Program erforderlich
Selection by V.S.P. Valve Selection Program required

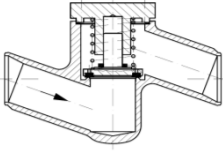
T5VAF-RUV/TF		Rückschlagventil, Durchg.	Anschluss		Kvs	Gewicht	Preis
		Check Valve, Globe	Connection		Kvs	Weight	Price
 Oberteil geflanscht Bolted bonnet		Artikel-Nr. / Article-No.	DN	Inch	[m³/h]	[kg]	[EUR]
		5.015.VA.F-RUV/TF	15	1/2"	4,0	0,9	247,00 €
5.020.VA.F-RUV/TF	20	3/4"	7,0	1,2	266,00 €		
5.025.VA.F-RUV/TF	25	1"	13,0	2,1	319,00 €		
5.032.VA.F-RUV/TF	32	1-1/4"	13,0	2,4	369,00 €		
5.040.VA.F-RUV/TF	40	1-1/2"	23,0	3,8	602,00 €		
5.050.VA.F-RUV/TF	50	2"	31,0	5,1	797,00 €		
5.065.VA.F-RUV/TF	65	2-1/2"	65,0	15,5	1.476,00 €		
5.080.VA.F-RUV/TF	80	3"	94,0	17,3	1.626,00 €		
5.100.VA.F-RUV/TF	100	4"	142,0	23,8	1.819,00 €		

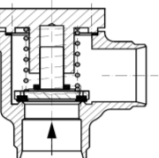
T6VA.F-RUV/TF		Rückschlagventil, Eck	Anschluss		Kvs	Gewicht	Preis
		Check Valve, Angle	Connection		Kvs	Weight	Price
 Oberteil geflanscht Bolted bonnet		Artikel-Nr. / Article-No.	DN	Inch	[m³/h]	[kg]	[EUR]
		6.015.VA.F-RUV/TF	15	1/2"	5,0	0,8	235,00 €
6.020.VA.F-RUV/TF	20	3/4"	7,0	1,0	263,00 €		
6.025.VA.F-RUV/TF	25	1"	14,0	1,8	309,00 €		
6.032.VA.F-RUV/TF	32	1-1/4"	21,0	2,1	360,00 €		
6.040.VA.F-RUV/TF	40	1-1/2"	23,0	3,2	485,00 €		
6.050.VA.F-RUV/TF	50	2"	53,0	4,2	602,00 €		
6.065.VA.F-RUV/TF	65	2-1/2"	69,0	10,0	1.098,00 €		
6.080.VA.F-RUV/TF	80	3"	140,0	17,8	1.414,00 €		
6.100.VA.F-RUV/TF	100	4"	188,0	23,4	1.553,00 €		

Rückschlagventile VA Check Valve SS

TG: Nur für Verdichterdruckleitung und Sauggasleitung
TG: Only for compressor discharge line and suction line

Standard: aus Edelstahl, PN25, mit ISO Anschweißenden
Standard: made of stainless steel, PN25, with butt weld ends ISO

Alternative: Anschweißenden mit Schweißfase nach ANSI, Schedule
Alternative: butt weld ends according ANSI, Schedule

Auslegung mit V.S.P. Valve Selection Program erforderlich
Selection by V.S.P. Valve Selection Program required

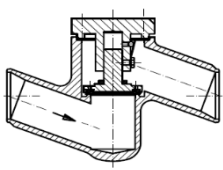
T5VA.F-RUV/TG		Rückschlagventil, Durchg.	Anschluss		Kvs	Gewicht	Preis
		Check Valve, Globe	Connection		Kvs	Weight	Price
		Artikel-Nr. / Article-No.	DN	Inch	[m³/h]	[kg]	[EUR]
		Oberteil geflanscht Bolted bonnet		5.015.VA.F-RUV/TG	15	1/2"	4,0
5.020.VA.F-RUV/TG	20			3/4"	7,0	1,2	266,00 €
5.025.VA.F-RUV/TG	25			1"	13,0	2,1	319,00 €
5.032.VA.F-RUV/TG	32			1-1/4"	13,0	2,4	369,00 €
5.040.VA.F-RUV/TG	40			1-1/2"	23,0	3,8	602,00 €
5.050.VA.F-RUV/TG	50			2"	31,0	5,1	797,00 €
5.065.VA.F-RUV/TG	65			2-1/2"	65,0	15,5	1.476,00 €
5.080.VA.F-RUV/TG	80			3"	94,0	17,3	1.626,00 €
5.100.VA.F-RUV/TG	100			4"	142,0	23,8	1.819,00 €

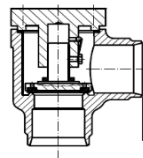
T6VA.F-RUV/TG		Rückschlagventil, Eck	Anschluss		Kvs	Gewicht	Preis
		Check Valve, Angle	Connection		Kvs	Weight	Price
		Artikel-Nr. / Article-No.	DN	Inch	[m³/h]	[kg]	[EUR]
		Oberteil geflanscht Bolted bonnet		6.015.VA.F-RUV/TG	15	1/2"	5,0
6.020.VA.F-RUV/TG	20			3/4"	7,0	1,0	263,00 €
6.025.VA.F-RUV/TG	25			1"	14,0	1,8	309,00 €
6.032.VA.F-RUV/TG	32			1-1/4"	21,0	2,1	360,00 €
6.040.VA.F-RUV/TG	40			1-1/2"	23,0	3,2	485,00 €
6.050.VA.F-RUV/TG	50			2"	53,0	4,2	602,00 €
6.065.VA.F-RUV/TG	65			2-1/2"	69,0	10,0	1.098,00 €
6.080.VA.F-RUV/TG	80			3"	140,0	17,8	1.414,00 €
6.100.VA.F-RUV/TG	100			4"	188,0	23,4	1.553,00 €

Absperr/Rückschlagv. VA Stop/Check Valve SS

Auslegung mit V.S.P. Valve Selection Program erforderlich
Selection by V.S.P. Valve Selection Program required

Standard: aus Edelstahl, PN25, mit ISO Anschweißenden, Kappe
Standard: made of stainless steel, PN25, with butt weld ends ISO, cap

Alternative: Anschweißenden mit Schweißfase nach ANSI, Schedule
Alternative: butt weld ends according ANSI, Schedule

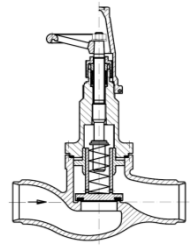
T5VA.F.RUV/AV		Rückschlagventil, Durchg.	Anschluss		Kvs	Gewicht	Preis
		Check Valve, Globe	Connection		Kvs	Weight	Price
		Artikel-Nr. / Article-No.	DN	Inch	[m³/h]	[kg]	[EUR]
		Oberteil geflanscht Bolted bonnet		5.015.VA.F.RUV/AV.K	15	1/2"	
5.020.VA.F.RUV/AV.K	20			3/4"		2,2	542,00 €
5.025.VA.F.RUV/AV.K	25			1"		3,6	705,00 €
5.032.VA.F.RUV/AV.K	32			1-1/4"		4,3	791,00 €
5.040.VA.F.RUV/AV.K	40			1-1/2"		5,5	865,00 €
5.050.VA.F.RUV/AV.K	50			2"		6,6	#NV
5.065.VA.F.RUV/AV.K	65			2-1/2"		24,2	#NV
5.080.VA.F.RUV/AV.K	80			3"		25,9	2.463,00 €
5.100.VA.F.RUV/AV.K	100			4"		32,7	#NV

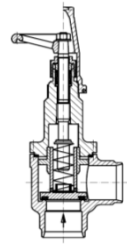
T6VA.F.RUV/AV		Rückschlagventil, Eck	Anschluss		Kvs	Gewicht	Preis
		Check Valve, Angle	Connection		Kvs	Weight	Price
		Artikel-Nr. / Article-No.	DN	Inch	[m³/h]	[kg]	[EUR]
		Oberteil geflanscht Bolted bonnet		6.015.VA.F.RUV/AV.K	15	1/2"	3,2
6.020.VA.F.RUV/AV.K	20			3/4"	5,7	2,0	539,00 €
6.025.VA.F.RUV/AV.K	25			1"	8,9	3,4	696,00 €
6.032.VA.F.RUV/AV.K	32			1-1/4"	14,5	3,7	756,00 €
6.040.VA.F.RUV/AV.K	40			1-1/2"	22,7	4,6	773,00 €
6.050.VA.F.RUV/AV.K	50			2"	35,4	5,7	882,00 €
6.065.VA.F.RUV/AV.K	65			2-1/2"	59,8	18,0	1.837,00 €
6.080.VA.F.RUV/AV.K	80			3"	90,7	18,4	2.252,00 €
6.100.VA.F.RUV/AV.K	100			4"	141,7	23,7	2.265,00 €

Absperr/Rückschlagventile VA, CO²

Stop/Check Valve SS CO²

Auslegung mit V.S.P. Valve Selection Program erforderlich
Selection by V.S.P. Valve Selection Program required

Standard: aus Edelstahl, PN40, mit ISO Anschweißenden, Kappe
Standard: made of stainless steel, PN40, with butt weld ends ISO, cap

Alternative: Anschweißenden mit Schweißfase nach ANSI, Schedule
Alternative: butt weld ends according ANSI, Schedule

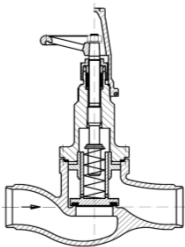
T5VA.F.RUV/AV-CO2		Rückschlagventil, Durchg,	Anschluss		Kvs	Gewicht	Preis
		Check Valve, Globe	Connection		Kvs	Weight	Price
 Oberteil geflanscht Bolted bonnet		Artikel-Nr. / Article-No.	DN	Inch	[m ³ /h]	[kg]	[EUR]
		5.015.VA.F.RUV/AV-CO2.K	15	1/2"		1,7	#NV
5.020.VA.F.RUV/AV-CO2.K	20	3/4"		2,2	#NV		
5.025.VA.F.RUV/AV-CO2.K	25	1"		3,6	#NV		
5.032.VA.F.RUV/AV-CO2.K	32	1-1/4"		4,3	791,00 €		
5.040.VA.F.RUV/AV-CO2.K	40	1-1/2"		5,5	#NV		
5.050.VA.F.RUV/AV-CO2.K	50	2"		6,6	#NV		
5.065.VA.F.RUV/AV-CO2.K	65	2-1/2"		24,2	#NV		
5.080.VA.F.RUV/AV-CO2.K	80	3"		25,9	#NV		
5.100.VA.F.RUV/AV-CO2.K	100	4"		32,7	#NV		

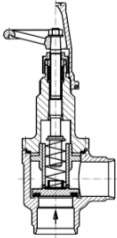
T6VA.F.RUV/AV-CO2		Rückschlagventil, Eck	Anschluss		Kvs	Gewicht	Preis
		Check Valve, Angle	Connection		Kvs	Weight	Price
 Oberteil geflanscht Bolted bonnet		Artikel-Nr. / Article-No.	DN	Inch	[m ³ /h]	[kg]	[EUR]
		6.015.VA.F.RUV/AV-CO2.K	15	1/2"	3,2	1,6	#NV
6.020.VA.F.RUV/AV-CO2.K	20	3/4"	5,7	2,0	551,00 €		
6.025.VA.F.RUV/AV-CO2.K	25	1"	8,9	3,4	714,00 €		
6.032.VA.F.RUV/AV-CO2.K	32	1-1/4"	14,5	3,7	#NV		
6.040.VA.F.RUV/AV-CO2.K	40	1-1/2"	22,7	4,6	903,00 €		
6.050.VA.F.RUV/AV-CO2.K	50	2"	35,4	5,7	1.089,00 €		
6.065.VA.F.RUV/AV-CO2.K	65	2-1/2"	59,8	18,0	2.261,00 €		
6.080.VA.F.RUV/AV-CO2.K	80	3"	90,7	18,4	#NV		
6.100.VA.F.RUV/AV-CO2.K	100	4"	141,7	23,7	2.583,00 €		

Sicherheitsventile VA BPD

Safety Valves SS BPD

Edelstahl, bauteilgeprüft, gegendruckabhängig, auch für CO₂ geeignet, bei Bestellung bitte Einstelldruck angeben!
Stainless Steel, component tested, back pressure dependent, also suitable for CO₂, please advice set pressure on order!

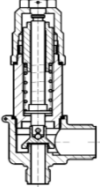
T21.1VA		Sicherheitsventil		Anschluss		+ Schweißnippel	Gewicht	Preis	
		Safety Valve		Connection		+ weld nipple	Weight	Price	
		Artikel-Nr. / Article-No.		ein/in	aus/out	ein/in	aus/out	[kg]	[EUR]
		Gewindeanschluss, PN40 Druckbereich 3,5 bis 40 bar ü Threaded ends, PN40 Pressure Range 3.5 to 40 bar g		21.1.012.VA		G1/2"	G1"	-	-
21.1.012.VA.A/B				G1/2"	G1"	-	DN25	2,3	608,00 €
21.1.012.VA.B/B				G1/2"	G1"	DN15	DN25	2,3	690,00 €
21.1.012.VA.D/B				G1/2"	G1"	DN25	DN25	2,3	738,00 €
		TÜV Einstellbescheinigung / Test Certificate by TÜV							Netto-Preis
		Kosten für Bescheinigungen werden netto ohne Abzug berechnet!							Net-Price
		Costs for test certificates will be charged without any discount !							[EUR]
		AZ/SECURITY	Kosten pro Ventil / costs for each valve					44,00 €	
		Sicherheitsventil		Anschluss		+ Schweißnippel	Gewicht	Preis	
		Safety Valve		Connection		+ weld nipple	Weight	Price	
		Artikel-Nr. / Article-No.		ein/in	aus/out	ein/in	aus/out	[kg]	[EUR]
		EINTR.B.21.VA		G1/2"			DN15		
		AUSTR.B.21.VA			G1"		DN25		140,00 €
		EINTR.D.21.VA		G1/2"			DN25		162,00 €

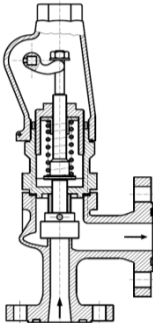
T23.1VA		Sicherheitsventil		Anschluss		Gewicht	Preis		
		Safety Valve		Connection		Weight	Price		
		Artikel-Nr. / Article-No.		ein/in	aus/out	[kg]	[EUR]		
		Flanschanschluß PN25 DIN2634 mit Nut EN1092-1 "D" Druckbereich 4,5 bis 27 bar ü Flanged Connection PN25 DIN2634 with groove EN1092-1 "D" Pressure Range 4.5 to 27 bar g		23.1.020.025.VA		DN20	DN25	8,2	or request
23.1.025.032.VA				DN25	DN32	9,9	on request		
		TÜV Einstellbescheinigung / Test Certificate by TÜV							Netto-Preis
		Kosten für Bescheinigungen werden netto ohne Abzug berechnet!							Net-Price
		Costs for test certificates will be charged without any discount !							[EUR]
		AZ/SECURITY	Kosten pro Ventil / costs for each valve					44,00 €	
		Sicherheitsventil		Anschluss		Gewicht	Preis		
		Safety Valve		Connection		Weight	Price		
		Artikel-Nr. / Article-No.		ein/in	aus/out	[kg]	[EUR]		
		FLADINF.020.VA.SMD		20	3/4"	2,5	160,00 €		
		FLADINF.025.VA.SMD		25	1"	2,9	162,00 €		
		FLADINF.032.VA.SMD		32	1-1/4"	4,1	190,00 €		

Dichtungen / Gaskets		Flanschdichtung	Inhalt	Anschluss		Größe	Preis
Gasket (Flange)		Content	Connection	Size		Price	
Artikel-Nr. / Article-No.		[pcs.]	DN	Inch	[mm]	[EUR]	
Flanschdichtung für Nut EN1092-1 Form D	Gasket (Flange) for groove EN1092-1 "D"	DI.FLANUT.015	1	15	1/2"	39x29x2	7,00 €
		DI.FLANUT.020	1	20	3/4"	50x36x2	7,00 €
		DI.FLANUT.025	1	25	1"	57x43x2	10,00 €
		DI.FLANUT.032	1	32	1-1/4"	65x51x2	10,00 €
		DI.FLANUT.040	1	40	1-1/2"	75x61x2	10,00 €
		DI.FLANUT.050	1	50	2"	87x73x2	13,00 €
		DI.FLANUT.065	1	65	2-1/2"	109x95x2	15,00 €

Schrauben, Muttern / Bolts, Nuts		Schrauben/Mutternsatz	Inhalt	Anschluss		Größe	Preis
Bolts/Nuts Kit		Content	Connection	Size		Price	
Artikel-Nr. / Article-No.		[pcs.]	DN	Inch	[mm]	[EUR]	
	Schrauben/Mutternsatz Bolts/Nuts Kit	SM.015.FLADIN	4	15-25	1/2" to 1"	M12x50	20,00 €
		SM.032.FLADIN	4	32-50	1-1/4" to 2"	M16x55	39,00 €
		SM.065.FLADIN	8	65	2-1/2"	M16x60	75,00 €

Dichtungen / Gaskets		Flanschdichtung	Inhalt	Anschluss		Größe	Preis
Gasket (Flange)		Content	Connection	Size		Price	
Artikel-Nr. / Article-No.		[pcs.]	DN	Inch	[mm]	[EUR]	
nur für neue Sicherheitsventile auf alte Wechselventile ! only for new safety valves on old changeover valves !	Flanschdichtung 3mm für Nut EN1092-1 Form D	DI.FLANUT.015.3DK	1	15	1/2"	39x29x3	13,00 €
		DI.FLANUT.020.3DK	1	20	3/4"	50x36x3	13,00 €
		DI.FLANUT.025.3DK	1	25	1"	57x43x3	18,00 €
		DI.FLANUT.032.3DK	1	32	1-1/4"	65x51x3	18,00 €
		DI.FLANUT.040.3DK	1	40	1-1/2"	75x61x3	18,00 €
		DI.FLANUT.050.3DK	1	50	2"	87x73x3	23,00 €

Sicherheitsventile VA BPI

Safety Valves SS BPI

Edelstahl, bauteilgeprüft, gegendruckunabhängig, auch für CO2 geeignet, bei Bestellung bitte Einstelldruck angeben!
Stainless Steel, component tested, back pressure independent, also suitable for CO2, please advice set pressure on order!

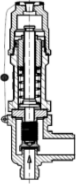
T21VA.FA		Sicherheitsventil	Anschluss		+ Schweißnippel	Gewicht	Preis	
		Safety Valve	Connection		+ weld nipple	Weight	Price	
 <p>Gewindeanschluss, PN40 Druckbereich 6,5 bis 40 bar ü Threaded ends, PN40 Range 6.5 to 40 bar g</p>		Artikel-Nr. / Article-No.	ein/in	aus/out	ein/in	aus/out	[kg]	[EUR]
		21.1.012.VA.FA	G1/2"	G1"	-	-	1,8	613,00 €
		21.1.012.VA.FA.A/B	G1/2"	G1"	-	DN25	2,5	669,00 €
		21.1.012.VA.FA.B/B	G1/2"	G1"	DN15	DN25	2,5	812,00 €
		21.1.012.VA.FA.D/B	G1/2"	G1"	DN25	DN25	2,5	870,00 €
TÜV Einstellbescheinigung / Test Certificate by TÜV							Netto-Preis	
Kosten für Bescheinigungen werden netto ohne Abzug berechnet!							Net-Price	
Costs for test certificates will be charged without any discount !							[EUR]	
AZ/SECURITY							Kosten pro Ventil / costs for each valve	44,00 €

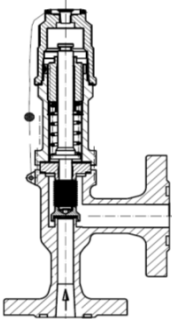
T21VA.F.FA		Sicherheitsventil	Anschluss		Gewicht	Preis		
		Safety Valve	Connection		Weight	Price		
 <p>Flanschschluß PN25/40 DIN2634 mit Nut EN1092-1 "D" Druckbereich 6,5 bis 40 bar ü Flanged Connection PN25/40 DIN2634 with groove EN1092-1 "D" Range 6.5 to 40 bar g</p> <p>Edelstahl, PN25/40 Schweißenden DIN2634 mit Feder EN1092-1 "C" mit Schrauben, Muttern und Dichtungen Stainless Steel, PN25/40 ISO Butt Weld Ends DIN2634 with tongue EN1092-1 "C" with bolts, nuts and gasket</p>		Artikel-Nr. / Article-No.	ein/in	aus/out	[kg]	[EUR]		
		21.1.015.020.VA.F.FA	DN15	DN20		3,7	1.167,00 €	
		21.1.015.025.VA.F.FA	DN15	DN25			1.167,00 €	
		21.1.020.020.VA.F.FA	DN20	DN20		3,9	1.167,00 €	
		21.1.020.025.VA.F.FA	DN20	DN25		4,2	1.167,00 €	
		21.1.025.025.VA.F.FA	DN25	DN25	4,5	1.167,00 €		
TÜV Einstellbescheinigung / Test Certificate by TÜV							Netto-Preis	
Kosten für Bescheinigungen werden netto ohne Abzug berechnet!							Net-Price	
Costs for test certificates will be charged without any discount !							[EUR]	
AZ/SECURITY							Kosten pro Ventil / costs for each valve	44,00 €
<p>Flansch 1 Stk. (Stückzahl beachten)</p> <p>Flange 1pc. (take care of quantity)</p>		Artikel-Nr. / Article-No.	DN	Inch	[kg]	[EUR]		
		FLADINF.015.VA.SMD	15	1/2"	1,8	144,00 €		
		FLADINF.020.VA.SMD	20	3/4"	2,5	160,00 €		
		FLADINF.025.VA.SMD	25	1"	2,9	162,00 €		

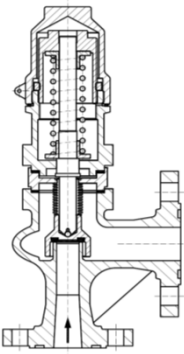
T23.1VA.FA		Sicherheitsventil	Anschluss		Gewicht	Preis				
		Safety Valve	Connection		Weight	Price				
 <p>Flanschschluß PN25 DIN2634 mit Nut EN1092-1 "D" Druckbereich 10 bis 27 bar ü Flanged Connection PN25 DIN2634 with groove EN1092-1 "D" Pressure Range 10 to 27 bar g</p> <p>Stahl, PN25/40 Schweißenden DIN2634 mit Feder EN1092-1 "C" mit Schrauben, Muttern und Dichtungen Steel, PN25/40 ISO Butt Weld Ends DIN2634 with tongue EN1092-1 "C" with bolts, nuts and gasket</p>		Artikel-Nr. / Article-No.	ein/in	aus/out	[kg]	[EUR]				
		23.1.025.032.VA.FA	DN25	DN32		9,3	on request			
		TÜV Einstellbescheinigung / Test Certificate by TÜV							Netto-Preis	
		Kosten für Bescheinigungen werden netto ohne Abzug berechnet!							Net-Price	
Costs for test certificates will be charged without any discount !							[EUR]			
AZ/SECURITY							Kosten pro Ventil / costs for each valve	44,00 €		
<p>Flansch 1 Stk. (Stückzahl beachten)</p> <p>Flange 1pc. (take care of quantity)</p>		Artikel-Nr. / Article-No.	DN	Inch	[kg]	[EUR]				
		FLADINF.025.VA.SMD	25	3/4"	2,9	162,00 €				
		FLADINF.032.VA.SMD	32	1-1/4"	4,1	190,00 €				

Dichtungen / Gaskets		Flanschdichtung	Inhalt	Anschluss		Größe	Preis
Gasket (Flange)		Gasket (Flange)	Content	Connection		Size	Price
Artikel-Nr. / Article-No.		[pcs.]	DN	Inch	[mm]	[EUR]	
Flanschdichtung für Nut EN1092-1 Form D	Gasket (Flange) for groove EN1092-1 "D"	1	15	1/2"	39x29x2	7,00 €	
		1	20	3/4"	50x36x2	7,00 €	
		1	25	1"	57x43x2	10,00 €	
		1	32	1-1/4"	65x51x2	10,00 €	
		1	40	1-1/2"	75x61x2	10,00 €	
		1	50	2"	87x73x2	13,00 €	
		1	65	2-1/2"	109x95x2	15,00 €	

Schrauben, Muttern / Bolts, Nuts		Schrauben/Mutternsatz	Inhalt	Anschluss		Größe	Preis
Bolts/Nuts Kit		Bolts/Nuts Kit	Content	Connection		Size	Price
Artikel-Nr. / Article-No.		[pcs.]	DN	Inch	[mm]	[EUR]	
Schrauben/Mutternsatz Bolts/Nuts Kit		4	15-25	1/2" to 1"	M12x50	20,00 €	
		4	32-50	1-1/4" to 2"	M16x55	39,00 €	
		8	65	2-1/2"	M16x60	75,00 €	

Bilder sind nur zur Orientierung!
Pictures are for orientation only!

3-Wege-Ventile VA 3-Way-Valves SS

Edelstahl, handbetätigt, mit Kappe, PN25
Stainless steel manual actuated, with cap, PN25

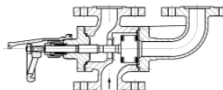
T25VA		3-Wegeventil	Anschluss		Gewicht	Preis	
		3-Way Valves	Connection				Weight
 <p>Flanschanschluß PN25 DIN2634 Eintritt Nut EN1092-1 "D" Austritt Feder Form "C" Flanged Connection PN25 DIN2634 inlet groove EN1092-1 "D" outlet tongue face "C"</p>		Artikel-Nr. / Article-No.	ein/in	aus/out	[kg]	[EUR]	
				25.015.VA.K	DN15	DN15	10,0
		25.020.VA.K	DN20	DN20	9,6	obsolete	
		25.025.VA.RED.K	DN25	DN20	11,7	obsolete	
		25.025.VA.K	DN25	DN25	11,7	obsolete	
		Zusammenbaukit für T24VA (Sicherheitsventilkombination)				Preis	
		Assembling Kit for T24VA (Dual-Safety-Valve)				Price	
		Artikel-Nr. / Article-No.			[kg]	[EUR]	
		24.015.KIT	für 1xT25V zusammen mit 2xT23V			61,00 €	
		24.020.KIT	für 1xT25V zusammen mit 2xT23V			61,00 €	
		24.025.KIT	für 1xT25V zusammen mit 2xT23V			62,00 €	

T25VA-CO2		3-Wege-Ventil für CO2	Anschluss		Gewicht	Preis
		3-Way Valves	Connection			
 <p>Flanschanschluß PN25 DIN2634 Eintritt Nut EN1092-1 "D" Austritt Feder Form "C" Flanged Connection PN25 DIN2634 inlet groove EN1092-1 "D" outlet tongue face "C"</p>		Artikel-Nr. / Article-No.	ein/in	aus/out	[kg]	[EUR]
				25.015.VA-CO2.K	DN15	DN15
		25.020.VA-CO2.K	DN20	DN20	9,6	obsolete
		25.025.VA-CO2.K	DN25	DN25	11,7	obsolete

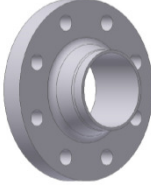
Gegenflansche / Counterflanges		Flansche (3 werden benötigt)	Anschluss		Gewicht	Preis
		Flanges (you need 3 pcs.)	Connection			
 <p>Edelstahl, PN25/40 Schweißenden DIN2634 mit Feder EN1092-1 "C" mit Schrauben, Muttern und Dichtungen Stainless Steel, PN25/40 ISO Butt Weld Ends DIN2634 with tongue EN1092-1 "C" with bolts, nuts and gasket</p>		Artikel-Nr. / Article-No.	DN	Inch	[kg]	[EUR]
				FLADINF.015.VA.SMD	15	1/2"
		FLADINF.020.VA.SMD	20	3/4"	2,5	160,00 €
		FLADINF.025.VA.SMD	25	1"	2,9	162,00 €

Sicherheitsventil-Kombi. VA BPD Dual Safety Valves SS BPD

Edelstahl, bauteilgeprüft, gegendruckabhängig, bei Bestellung bitte Einstelldruck angeben!
Stainless Steel, component tested, back pressure dependent, please advice set pressure on order!

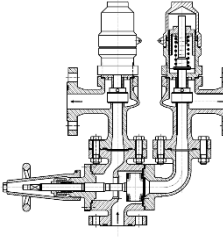
T24.1VA NEW		Sicherheitsventilkombi.	Anschluss		Gewicht	Preis	
		Dual Safety Valve	Connection				Weight
 <p>Flanschanschluß PN25 DIN2634 mit Nut EN1092-1 "D" Druckbereich 4,5 bis 27 bar ü DIN2634 with groove EN1092-1 "D" Range 4.5 to 27 bar g Edelstahl, PN25/40 Schweißenden DIN2634 mit Feder EN1092-1 "C" mit Schrauben, Muttern und Dichtungen Stainless Steel, PN25/40 ISO Butt Weld Ends DIN2634 with tongue EN1092-1 "C" with bolts, nuts and gasket</p>		Artikel-Nr. / Article-No.	ein/in	aus/out	[kg]	[EUR]	
				24.1.020.025.VA.K	20	25	8,2
		24.1.025.032.VA.K	25	32	9,9	obsolete	
		TÜV Einstellbescheinigung / Test Certificate by TÜV				Netto-Preis	
		Kosten für Bescheinigungen werden netto ohne Abzug berechnet!				Net-Price	
		Costs for test certificates will be charged without any discount !				[EUR]	
		Es werden 2 Bescheinigungen benötigt / you need 2 certificates					
		AZ/SECURITY					44,00 €
		Flansch 1 Stk. (Stückzahl beachten)		Anschluss	Gewicht	Preis	
		Flange 1pc. (take care of quantity)		Connection	Weight	Price	
		Artikel-Nr. / Article-No.	DN	Inch	[kg]	[EUR]	
		FLADINF.020.VA.SMD	20	3/4"	2,5	160,00 €	
		FLADINF.025.VA.SMD	25	1"	2,9	162,00 €	
		FLADINF.032.VA.SMD	32	1-1/4"	4,1	190,00 €	

Berstscheiben Bursting Disc

als Ergänzung zu Wechselsicherheits-Kombination
as supplementation to dual safety valves combinations

KUB+HAL	Berstscheibensatz	Anschl.	Test-Zertifikat	Gewicht	Preis/Stück
	Bursting Disc Set	Conn.	Test Certificate	Weight	Price/each
	Artikel-Nr. / Article-No.	DN		[kg]	[EUR]
Berstscheiben-Satz in Flanschausführung für T21F, T23V, T19F, T24/V bestehend aus: 1 x Berstscheiben-Aufnahmeeinheit IG-KUB-FN-S 1 x Knickstab-Umkehr-Berstscheibe BT-KUB* * Mindestbestellmenge für Berstscheiben: 2 Stück pro DN und Berstdruck! Berstscheibe vakuumbeständig fragmentationsfreie Öffnung Entspannungsventil Typ PV erforderlich! Auslaßteil mit je zwei Gewindebohrungen G1/4", mit Blindstopfen versehen belastbar bis 90% des spezifizierten Berstdrucks Bursting disc set flanged design for T21F, T23/V, T19F, T24/V existing of: 1 x Bursting disc holder IG-KUB-FN-S 1 x Reverse buckling-pin bursting disc BT-KUB* * Minimum order quantity for bursting discs: 2 pieces per DN and bursting pressure! Bursting disc set flanged design Bursting disc vacuum-resistant non fragmentation design outlet-part with two bores G1/4", sealed with bolts max. allowable working pressure 90% of bursting pressure	KUB+HAL.015.TUEV	15	TÜV		1.702,00 €
	KUB+HAL.020.TUEV	20	TÜV		1.714,00 €
	KUB+HAL.025.TUEV	25	TÜV		1.737,00 €
	KUB+HAL.032.TUEV	32	TÜV		1.880,00 €
	KUB+HAL.040.TUEV	40	TÜV		2.266,00 €
	KUB+HAL.050.TUEV	50	TÜV		2.680,00 €
	KUB+HAL.015.WERK	15	Factory Test		1.541,00 €
	KUB+HAL.020.WERK	20	Factory Test		1.554,00 €
	KUB+HAL.025.WERK	25	Factory Test		1.576,00 €
	KUB+HAL.032.WERK	32	Factory Test		1.719,00 €
KUB+HAL.040.WERK	40	Factory Test		2.076,00 €	
KUB+HAL.050.WERK	50	Factory Test		2.489,00 €	
Achtung: Berstdrucktoleranz +/-10% / Berstdrücke bei 22°C abweichende Temperaturen müssen ausdrücklich bestellt werden! Entspannungsventil Typ PV erforderlich! Please note: tolerance of bursting pressure +/-10% / bursting pressure at 22°C other temperatures have to be ordered specially Excess Flow Valve Type PV required!					
Zusammenbau-Kit: für Montage von 2 KUB+HAL mit 1 x T25V und 2 x T23V mit Bolzen, Muttern und Dichtungen zu einer Wechsel-Sicherheitsventil-Kombination mit Berstscheiben Assembling Kit: for assembling of 2 KUB+HAL together with 1 x T25V and 2 x T23V together with bolts, nuts and gaskets to have a dual safety valve combination with bursting discs	Zusammenbaukit für T19F.KUB (Sicherheitsventilkombination)				Preis
	Assembling Kit for T19F.KUB (Dual-Safety-Valve)				Price
	Artikel-Nr. / Article-No.				[EUR]
	19.015.F.KUB.KIT	für 1xT25V zusammen mit 2xT21F			258,00 €
	19.015.F.KUB.KIT	für 1xT25V zusammen mit 2xT21F			258,00 €
	19.025.F.KUB.KIT	für 1xT25V zusammen mit 2xT21F			263,00 €
	Zusammenbaukit für T24V.KUB (Sicherheitsventilkombination)				Preis
	Assembling Kit for T24V.KUB (Dual-Safety-Valve)				Price
	Artikel-Nr. / Article-No.				[EUR]
	24.015.KUB.KIT	für 1xT25V zusammen mit 2xT23V			233,00 €
24.020.KUB.KIT	für 1xT25V zusammen mit 2xT23V			235,00 €	
24.025.KUB.KIT	für 1xT25V zusammen mit 2xT23V			237,00 €	
24.032.KUB.KIT	für 1xT25V zusammen mit 2xT23V			287,00 €	
24.040.KUB.KIT	für 1xT25V zusammen mit 2xT23V			288,00 €	
24.050.KUB.KIT	für 1xT25V zusammen mit 2xT23V			291,00 €	

UKB	Berstscheibeneinheit	Anschl.	Test-Zertifikat	Gewicht	Preis/Stück
	Bursting Disc Unit	Conn.	Test Certificate	Weight	Price/each
	Artikel-Nr. / Article-No.			[kg]	[EUR]
Berstscheiben-Einheit mit Gewindeanschluss GG-UKB-LS 0,75 für T21, T19 Mindestbestellmenge: 2 Stück Berstscheibe ohne Vakuumstütze absolut vakuumbeständig fragmentationsfreie Öffnung Eintritt: G1/2"L innen - Austritt: G1/2"L aussen Auslaßteil mit je zwei Gewindebohrungen G1/8", mit Blindstopfen versehen belastbar bis 90% des spezifizierten Berstdrucks Bursting disc unit with threaded connections GG-UKB-LS 0,75 for T21, T19 Minimum order quantity: 2 pieces without vacuum support absolutely vacuum-resistant non fragmentation design Inlet: G1/2"L female - outlet: G1/2"L male outlet-part with two bores G1/8", sealed with bolts max. allowable working pressure 90% of bursting pressure	UKB.012.TUEV	G1/2"L	TÜV		1.361,00 €
	UKB.012.WERK	G1/2"L	Factory Test		1.152,00 €
	Zusammenbaukit für T19.UKB (Sicherheitsventilkombination)				Preis
Assembling Kit for T19.UKB (Dual-Safety-Valve)				Price	
Artikel-Nr. / Article-No.				[EUR]	
19.012.UKB.KIT	für 1xT19A zusammen mit 2xT21			86,00 €	
Achtung: Berstdrucktoleranz +/-10% / Berstdrücke bei 22°C abweichende Temperaturen müssen ausdrücklich bestellt werden! Entspannungsventil Typ PV erforderlich! Please note: tolerance of bursting pressure +/-10% / bursting pressure at 22°C other temperatures have to be ordered specially Excess Flow Valve Type PV required!					

Entspannungsventile Excess Flow Valves

als Ergänzung zur Berstscheibe
as supplementation to bursting disc

EV	Entspannungsventil	Anschl.	geeignet für	Gewicht	Preis
	Excess Flow Valve	Conn.	suitable for	Weight	Price
	Artikel-Nr. / Article-No.	NPT		[kg]	[EUR]
Stahl Steel	ENTSPANNV1/8	1/8"	UKB	0,2	900,00 €
	ENTSPANNV1/4	1/4"	KUB	0,2	785,00 €

Schaugläser Sight Glasses

T111		Schaugläser		Anschluss		Gewicht	Preis
		Sight Glasses		Connection		Weight	Price
 Edelstahl mit Anschweißenden Stainless Steel with butt weld ends		Artikel-Nr. / Article-No.		DN	Inch	[kg]	[EUR]
		111.015	15	1/2"	2,0	#NV	
		111.020	20	3/4"	2,1	#NV	
		111.025	25	1"	2,7	#NV	
		111.032	32	1-1/4"	5,5	#NV	
		111.040	40	1-1/2"	5,6	#NV	
		111.050	50	2"	8,5	#NV	
		111.065	65	2-1/2"	12,0	#NV	
111.080	80	3"	13,0	#NV			

SG1		Schaugläser		Anschluss		Gewicht	Preis
		Sight Glasses		Connection		Weight	Price
 Stahl mit Anschweißanschluss mit Glas-Reflex-Linse Länge 50mm Steel with butt weld end with glas-reflex-lens length 2"		Artikel-Nr. / Article-No.				[kg]	[EUR]
		SG1				1	211,00 €

Flüssigkeitsstandkontrolle Liquid Level Controls

HBSR		NH3 Flüssigkeitsschalter		Ausgang		Anschluss		Gewicht	Preis
		NH3 Liquid Switch		Outlet		Connection		Weight	Price
 Edelstahl Stainless Steel		Artikel-Nr. / Article-No.						[kg]	[EUR]
		HBSR-PNP/NO-6	PNP	NO	3/4" BSPP	0,5	411,00 €		
		HBSR-PNP/NC-6	PNP	NC	3/4" BSPP	0,5	411,00 €		
		HBSR-PNP/NO-2	PNP	NO	3/4" NPT	0,5	411,00 €		
		HBSR-PNP/NC-2	PNP	NC	3/4" NPT	0,5	411,00 €		

HBSC2		CO2 Flüssigkeitsschalter		Ausgang		Anschluss		Gewicht	Preis
		CO2 Liquid Switch		Outlet		Connection		Weight	Price
 Edelstahl Stainless Steel		Artikel-Nr. / Article-No.						[kg]	[EUR]
		HBSC2-PNP/NO-6	PNP	NO	3/4" BSPP	0,6	on request		
		HBSC2-PNP/NC-6	PNP	NC	3/4" BSPP	0,6	on request		
		HBSC2-PNP/NO-2	PNP	NO	3/4" NPT	0,6	on request		
		HBSC2-PNP/NC-2	PNP	NC	3/4" NPT	0,6	on request		

HBSO1		Öl Flüssigkeitsschalter		Ausgang		Anschluss		Gewicht	Preis
		Oil Liquid Switch		Outlet		Connection		Weight	Price
 Edelstahl Stainless Steel		Artikel-Nr. / Article-No.						[kg]	[EUR]
		HBSO1-PNP/NO-6	PNP	NO	3/4" BSPP	0,3	on request		
		HBSO1-PNP/NC-6	PNP	NC	3/4" BSPP	0,3	on request		
		HBSO1-PNP/NO-2	PNP	NO	3/4" NPT	0,3	on request		
		HBSO1-PNP/NC-2	PNP	NC	3/4" NPT	0,3	on request		

HBHE		Heizung		Anschluss		Gewicht	Preis
		Heating Element		Connection		Weight	Price
 Spannung: 24V/DC Supply: 24V/DC		Artikel-Nr. / Article-No.				[kg]	[EUR]
		HBHE/L					on request
Als Frostschutz für HBSR und HBSC2. Erforderlich für Flüssigkeitstemperaturen unter -22°C. For keeping HBSR and HBSC2 electronics free from ice, recommended at liquid temp. below -22 deg.F/-30 deg.C							

HBLT-Wire		Niveausonde		Anschluss		Gewicht	Preis
		Liquid Level Sensor		Connection		Weight	Price
 Edelstahl Stainless Steel		Artikel-Nr. / Article-No.				[kg]	[EUR]
		HBLT-WIRE-6				3/4" BSPP	1.908,00 €
		HBLT-WIRE-2				3/4" NPT	1.908,00 €

Abnahmen & Bescheinigungen

Tests & Certificates

Kosten für Abnahmen und Bescheinigungen werden netto ohne Abzug berechnet!
Costs for inspections and certificates will be charged without discount !

Abnahmen & Bescheinigungen*	Kosten werden netto ohne Abzug berechnet.		Nettopreis
	Artikel-Nr.		[EUR]
Herstellerbescheinigung nach DIN-EN 1020/2.2	AZ/2.2	Kosten pro Ventil-Typ und DN	26,00 €
Herstellerbescheinigung nach DIN-EN 1020/3.1	AZ/3.1	Kosten pro Ventil-Typ und DN	50,00 €
Einstellbescheinigung durch Lloyd's Register für alle einzelnen Sicherheitsventile	AZ/SECURITY	Kosten pro Sicherheitsventil	44,00 €
Bescheinigung nach ROSTECHNADSOR für alle Sicherheitsventile u. Sicherheitsventil-Kombinationen	AZ/TR.SV	Kosten pro Ventil, z.B. für 1 SV-Ventil bzw. für 1 SV-Kombination	86,00 €
Bescheinigung nach GOST für alle Absperr-, Regel-, Rückschlag-, Wechselventile, Schmutzsammler, Sicherheitsventile, Sicherheitsventil-Kombinationen	AZ/TR	Kosten pro Ventil-Gruppe (Absperrventil = eine Gruppe usw.)	58,00 €
Abnahme durch Dritte, Bitte bei der Bestellung bekanntgeben. (LRS, GL, DNV, BV)		Kosten nach Aufwand	←
Ursprungszeugnis	AZ/COO	Kosten pro Ventil-Gruppe	97,00 €
Postversand, bzw. Dokumentenbeilage		Kosten je Dokument	#NV
Zuschlag für nachträglich erstellte Dokumente* (für bereits ausgelieferte Ware)			Nettopreis
			[EUR]
1 - 5 Dokumente		zusätzliche Kosten je Satz	#NV
6 - 10 Dokumente		zusätzliche Kosten je Satz	#NV
11 - 15 Dokumente		zusätzliche Kosten je Satz	#NV
> 15 Dokumente		Kosten auf Anfrage	←
Postversand, bzw. Dokumentenbeilage		Kosten je Dokument	#NV

* Alle Dokumente werden generell per E-Mail versendet.
Der Zuschlag versteht sich zuzüglich zu den Bescheinigungskosten.

Tests & Certificates*	Non-discountable items		Price Net
	Article-No.		[EUR]
Manufacturer's Certificate acc. to DIN-EN 10204/2.2	AZ/2.2	costs for each type and size	26,00 €
Manufacturer's Certificate acc. to DIN-EN 10204/3.1	AZ/3.1	costs for each type and size	50,00 €
Set pressure test Certificate by Lloyd's Register for all single safety valves	AZ/SECURITY	costs for each safety valve	44,00 €
Test Certificate acc. to ROSTECHNADSOR for single safety valves and dual safety valves	AZ/TR.SV	costs for each valve pass, e.g. for 1 safety valve or for 1 combination	86,00 €
Test Certificate acc. to GOST for shut-off-, regulating-, check-, 3-way-valves, strainer, safety valves, dual safety valves	AZ/TR	costs for each valve group (shut-off valves = 1 group, etc.)	58,00 €
Inspection by third parties, please specify on order (LRS, GL, DNV, BV)		costs acc. to expenditure	←
Certificate of Origin	AZ/COO	costs for each valve group	97,00 €
Postal.- document dispatch		costs for each document	3,00 €
Surcharge for subsequently created documents* (for already delivered goods)			Nettopreis
			[EUR]
1 - 5 Documents		additional costs for each set	29,00 €
6 - 10 Documents		additional costs for each set	58,00 €
11 - 15 Documents		additional costs for each set	86,00 €
> 15 Documents		costs on request	←
Postal.- document dispatch		costs for each document	3,00 €

* All documents are generally sent by e-mail.
The surcharge is in addition to the certification costs.

Markierungen

TAG's

TAG	Kosten werden netto ohne Abzug berechnet.		Nettopreis
	Non-discountable items		Net price
	Artikel-Nr.		[EUR]
Stempeln mit einer TAG-Nummer Tagging with a stamp	TAG.LABEL		6,00 €
VA-Schild mit TAG-Nummer Tagging with a stamp on stainless steel label	TAG.PLATE		on request

General Conditions of Sale - Parker Hannifin GmbH

I. General

- (1) The present General Conditions of Sale of Parker Hannifin GmbH ("**Vendor**") ("**Conditions**") shall apply only to entrepreneurs in the sense of Art. 14 German Civil Code ("**Buyer**") with regard to the sale of machinery, integrated software and other products ("**Products**").
- (2) Offers, order confirmations, deliveries and services provided by the Vendor shall be undertaken solely on the basis of these Conditions.
- (3) The Conditions shall also govern all future business relationships including where this has not been expressly agreed again.
- (4) Counter-confirmations by the Buyer citing his Terms of Business and/or Purchase Conditions shall not be valid, even where the Vendor has not expressly taken exception to them.
- (5) Divergences from the present Conditions shall only be effective where they are confirmed in writing by the Vendor.

II. Offer and Conclusion of Contract

- (1) The Vendor's offers are subject to change except where they have been expressly specified as binding.
- (2) A contract shall be created only in conjunction with an order confirmation from the Vendor. The order confirmation may be issued in writing or in electronic form (including EDI, remote data transmission or machine-readable data carriers). This shall also apply to additions, amendments or supplementary agreements. The issue of an invoice shall be deemed an order confirmation. Any quotations are given without commitment and no agreement is concluded unless and until we have issued an order confirmation. Quotations shall be valid for a period of 30 (thirty) days from the date of issue or (if different) the period specified with the quotation itself.
- (3) Order or article numbers relate to the given latest issue of the Vendor's documents such as catalogues or brochures which also contain further technical details. These documents serve only to provide information where they are not specified as binding or unless they exactly correspond to the purpose of use contractually foreseen by the Contracting Parties. No guarantee is given for the precise unit weights as specified from time to time in the catalogue.
- (4) Drawings, sketches, dimensions, weights and other performance data shall only be binding where this has been expressly agreed in writing. All drawings and documents shall be returned automatically to the Vendor where no contract is effected.
- (5) Where it becomes apparent after conclusion of the contract that the Vendor's claim to consideration is endangered through the Buyer's inability to perform, in particular because of open, outstanding invoices, the Vendor shall be entitled to refuse performance of the contract until the Buyer has effected the consideration or provided security for same. The Vendor shall be entitled to withdraw from the contract where the Buyer fails to perform having been given an appropriate deadline for effecting the consideration or providing security for same. The Buyer's countervailing rights shall not be affected.

III. Prices and Payment Terms

- (1) The prices specified by the Vendor in his offers are subject to change except where they have been designated as binding. Unless otherwise stated in the order confirmation, prices shall be ex works/warehouse of the Vendor exclusive of packaging, postal charges, freight, other shipping charges, insurance and excise duty which shall be shown separately in the invoice. Packaging shall be charged at cost price. VAT is not included in the Vendor's prices. The rate valid at the time shall be shown separately in the invoice.
- (2) All of the Vendor's invoices shall be payable in Euro at the place specified by the Vendor net 30 days from the date of the invoice without deduction or within 14 days from the date of invoice with a 2% cash discount. Cash discounts shall not be permissible where existing payments from older, due invoices remain outstanding. Any applicable cash discounts are to be deducted from the gross invoice amount.
- (3) The Vendor shall be entitled, irrespective of contrary Buyer terms, to set off payments against the Buyer's older debts. Where costs and interest charges have already accrued, the Vendor shall be entitled to set off payments firstly against the costs, then against the interest charges and finally against the main payment.
- (4) A payment shall only be considered fulfilled when the corresponding sum has been received by the Vendor.
- (5) Where the Buyer falls into arrears with his payment obligations the Vendor is entitled, after a suitable deadline has elapsed, to demand that all outstanding debts be paid immediately or that other securities be provided.

IV. Setting Off, Right to Retention, Non-Assignability

- (1) The Buyer shall only be entitled to set off or retention with regard to claims which are undisputed or which have been recognised by declaratory judgment. Deductions because of defects shall be subject to the same restrictions.
- (2) The Buyer declares that his claims and obligations may be set off by the Vendor and his associated companies. Claims and obligations of the Buyer's associated companies may also be set off in the same way.
- (3) The Buyer's rights out of the contract and these Conditions are non-transferable.

V. Delivery and Performance Time

- (1) The dates and deadlines specified by the Vendor are subject to change unless expressly agreed otherwise in writing. Individual delivery time agreements shall be required for on demand and blanket orders.
- (2) Delivery deadlines shall commence on the day on which the Buyer's order is received by the Vendor. The Vendor's observance of his delivery obligation presumes that the Buyer shall meet his obligations properly and in full; in particular the Vendor must be in possession of all documents, parts, details and licences required from the Buyer and any agreed part-payments must have been made.
- (3) The day of delivery shall be the day on which the Buyer is notified that the goods are ready for collection. Where delivery is due, the day of delivery shall be the day on which the goods are handed over to the party effecting the transport.
- (4) Acceptable part deliveries and part-performances are permissible to a reasonable degree. Moreover unavoidable divergences in quantity of up to +/- 5-10% shall not be deemed as insufficient quantity.
- (5) The Vendor shall not be responsible for delivery and performance delays caused by force majeure. In the event of force majeure and labour disputes the Vendor shall be released from his obligation to perform for the duration of such interruption and to the extent of its effect. The Vendor is obliged to provide all necessary information and to adjust his obligations to the altered circumstances in good faith within the bounds of what may reasonably be expected. The Buyer shall only be entitled to withdraw from the contract where the agreed delivery time exceeds the duration of a force majeure event plus an appropriate extra deadline period. Prior to this, the right to withdraw shall only apply where the Vendor has informed the Buyer in writing that the delivery cannot be made by him or can no longer be made. The foregoing restriction shall not apply to transactions where time is of the essence.
- (6) Where the Vendor's delivery is delayed, and where a delivery date has been agreed in writing, the Buyer may withdraw from the contract once he has given the Vendor a suitable deadline for supplementary performance of at least 14 days save where, exceptionally, no such deadline is required.

Where the Buyer does not specify during such deadline period whether he insists on performance or intends to exercise his right to withdraw and where such declaration is not received by the Vendor within a further period of 7 days, the Vendor shall in turn be entitled to withdraw from the contract. The Buyer's right to claim damages pursuant to section X. below shall remain unaffected.

VI. Transfer of Risk

- (1) The risk shall transfer to the Buyer as soon as the goods have left the Vendor's works, an outside warehouse or, in the event of direct delivery of goods not manufactured by the Vendor himself, the warehouse of the subcontractor. Where the dispatch or collection of the goods is delayed or impossible on grounds for which the Vendor is not responsible, the risk shall transfer to the Buyer once the Vendor has notified his readiness to dispatch.
- (2) Goods delivered, even where they display minor defects, shall be accepted by the Buyer, irrespective of his rights as specified at section VIII. below.

see next page

VII. Right of Retention to Title

- (1) The delivered goods shall remain the property of the Vendor until the Buyer has met all obligations arising out of the business relationship.
- (2) Processing or mixture of goods subject to retention shall always be undertaken with the Vendor in the role of manufacturer yet shall not be binding upon him. Where the Vendor's part ownership lapses through confusion of goods it is herewith agreed that the Buyer's part ownership in the goods shall be transferred pro rata to the value of the invoice amount. The Buyer shall hold goods owned or part-owned by the Vendor at his own expense.
- (3) The Buyer undertakes to protect the goods owned or part-owned by the Vendor with the due care of a proper businessman against spoilage, deterioration or loss, also in regard to his buyers.
- (4) The Buyer is entitled to process and sell goods subject to retention in the normal course of business. Such goods may not be mortgaged or assigned as security. The Buyer herewith declares that he assigns any claims arising out of the resale of the goods subject to retention or on any other legal grounds, together with all ancillary rights, to the Vendor.
- (5) Where third parties wish to seize the goods subject to retention, the Buyer shall advise them of the Vendor's ownership and shall inform the Vendor without delay. Costs and damages shall be borne by the Buyer.
- (6) Where the Buyer is in arrears with payment, the Vendor shall be entitled to withdraw from the contract and shall recover the goods subject to retention at the Buyer's expense or, where appropriate, shall demand that the Buyer assign any rights of recovery which the Buyer may have against third parties to the Vendor. The Vendor's right to claim damages shall remain unaffected. The same shall apply in the event of any other breach of contract by the Buyer.
- (7) The Vendor undertakes to release securities owed to him at the Buyer's request insofar as the realisable value of such securities does exceed the value of his claims by more than 20%. The securities thus released shall be determined at the Vendor's discretion.

VIII. Defect Claims

- (1) The Vendor shall be liable for ensuring that his products are free of manufacturing and material defects and that they are otherwise of the specification determined in the order confirmation. Except as provided in these terms and conditions or pursuant to the German Commercial Code, the Vendor disclaims all other guarantees, express and implied, including merchantability and fitness for a particular purpose. The Vendor shall only give guarantees where these are provided expressly in writing and designated as guarantees. The Buyer shall only have the right to claim for defects where he has properly fulfilled his inspection and notification obligations pursuant to Art. 377 German Commercial Code.
- (2) For products with integrated software a separate sales contract shall be concluded with regard to the software. A defect in such software does not represent a defect in the product as a whole unless the remaining product does not meet the standard agreed by Vendor and Buyer because of the software defect. Where such a quality has not been agreed, a software defect shall only represent a defect in the product as a whole where the product, owing to such software defect, is not suitable for the contractually agreed or usual use.
- (3) Industry-standard divergences shall only be deemed defects where this has been expressly agreed in writing by the Contracting Parties. The Vendor's declarations in his catalogues, brochures and price lists with regard to the items available and their performance serve only as descriptions, designations and guidelines, provided that this has not been otherwise agreed by the Contracting Parties in the order confirmation or in terms of the contractually agreed purpose. Minor, insignificant divergences compared with the catalogues or compared with previously delivered goods shall not be deemed defects.
- (4) The Buyer shall himself check whether the goods ordered from the Vendor are suitable for his intended purpose. Goods which are not suitable shall only be deemed defective where the Vendor has confirmed their suitability to the Buyer in writing.
- (5) Wear and tear of expendable parts during the course of normal use does not represent a defect.
- (6) Where the Vendor's instructions with regard to installation, fitting, operation or servicing are not observed, where alterations to the products are made, where parts are exchanged or consumables used which do not correspond with the original specifications, the right to claim for defects shall apply only where the Buyer can provide proof that the defect was not caused by such action but was already present at the time the risk was transferred.
- (7) Where the goods have not yet been delivered to the end consumer, the Vendor shall be obliged in the event of justified and properly notified defects to either remedy the defects or to replace the goods or parts thereof at his discretion. Where replacement deliveries or repairs fail, the Buyer may, at his discretion, only demand a discount or withdraw from the contract. The Buyer's right to withdraw and right to claim damages in place of full performance shall only apply where the defect is material. The Buyer's right to claim damages shall apply pursuant to section X. below.
- (8) Where the goods have already been delivered to an end consumer, the Buyer shall on principle only be entitled to make such defect claims against the Vendor as have been notified to him by his own buyer.
- (9) Defect claims cannot be made against the Vendor where the goods have been returned on the basis of goodwill arrangements not agreed with the Vendor. Furthermore the Buyer shall not be entitled to withdraw from the contract where he has been required to take back the goods because he has not properly fulfilled his obligation of supplementary performance and, in particular, where he has failed to fulfil his obligation of supplementary performance within a specified deadline.
- (10) The Buyer shall inform the Vendor in advance in writing of his own buyer's claim for supplementary performance and shall advise the Vendor of his proposed method of supplementary performance and the approximate associated costs. In the interests of the Vendor, the Buyer is obliged to keep expenditure as low as possible pursuant to Art. 439, para. 2 German Civil Code and to follow the Vendor's suggestions for a cheaper means of providing supplementary performance.
- (11) Where the Vendor is in breach of non performance-related obligations pursuant to Art. 241, para. 2 German Civil Code, the Buyer shall have the right to withdraw and the right to claim damages instead of performance where he may no longer be reasonably be expected to honour the contract.

Where a defect is to be remedied, the Vendor is obliged to bear all expenses, and in particular all transport, travel, labour and material costs which are necessarily incurred for the purpose of remedying the defect provided that such costs do not arise from the transportation of the given item to some place other than the place of performance.

- (12) Defect claims shall lapse 12 months from delivery of the goods to the Buyer. In the event of intent or negligence, section X. below shall apply.

IX. Software

The Vendor's software is not intended for private use. It may only be installed and/or used by qualified personnel who are familiar with the Vendor's installation and warning information.

Any incorrect installation, usage and/or servicing of the software by the Buyer may cause the software to malfunction and/or may cause damage to plant and/or machinery or people.

Where software defects are caused by the Buyer's failure to observe the Vendor's installation and warning instructions and/or the Buyer's improper use and/or servicing of the software, these shall not be covered by the Vendor's warranty obligation. Equally the Vendor accepts no liability for consequential losses resulting therefrom. This shall apply in particular with regard to any damage suffered by the software and/or consequential damage caused to machinery, plant, other products or people by the defective software.

X. Disclaimer

- (1) The Vendor's liability shall be unlimited in the event of intent or gross negligence, in relation to culpable injury to life, limb or health, for defects which he has deliberately concealed or in the event that he has provided a guarantee of quality or durability. The Vendor's liability shall also be unlimited within the scope of product liability and other liability legislation.
- (2) In the event of culpable violation of material contractual obligations, the Vendor shall also be liable for minor negligence although this shall be limited to contract-typical damages which may reasonably be foreseen at the time the contract is concluded. Material contractual obligations are those the violation of which endangers the object of the contract because those rights of the Buyer are thus taken or restricted which the Vendor is meant to be granting him under the terms of the contract.
- (3) Further damage claims, particularly claims relating to pecuniary loss, are excluded.
- (4) The above liability restrictions specified here at section X. also apply to employees, representatives, agents and assistants of the Vendor.

see next page

XI. Rights of Usage and Processing, Property Rights

(1) Insofar as the Vendor manufactures goods based on an order from the Buyer and in keeping with his instructions and guidelines and delivers these to the Buyer, the Buyer shall be liable to the Vendor with regard to ensuring that the deliveries and services ordered do not violate the property rights of any third party. He shall indemnify the Vendor against any such claims and shall compensate him for any losses thus incurred.

(2) Where the Vendor makes tools, drafts, installation suggestions or other drawings and documentation available to the Buyer together with the goods, the former shall retain title and all property and usage rights to such items. The Buyer shall only be entitled to usage within the scope of the sale contract; he shall in particular not be entitled to reproduce such items or make them available to third parties.

(3) Where the products in question are integrated software, the Buyer is entitled to use them to the extent defined in the contract. The intellectual property rights to the software and any manuals delivered with it shall remain unaffected. The Buyer may only reproduce the software and/or manuals or make them available to third parties where this is imperative under legislation. Art. 69 a et sqq. of the Copyright Act (UrhG) shall remain unaffected. The Vendor gives no guarantee and accepts no liability for the software where and insofar as it has been altered or improperly used by the Buyer.

XII. Non-Disclosure Clause

(1) Unless otherwise expressly agreed in writing, all information to which the Buyer is made privy within the scope of the contractual relationship shall be treated as confidential.

(2) Confidentiality shall not apply to such information

- of which the party who received the information ("receiving party") can verifiably demonstrate that it was already aware prior to disclosure provided that the receiving party informs the party which disclosed the information ("disclosing party") within one month of receipt of such information;

- which at the time of its disclosure to the receiving party was already in the public domain or accessible, or entered the public domain or became accessible after disclosure without any violation of this agreement on the part of the receiving party;

- that the receiving party shall receive from third parties provided that this information does not form part of a non-disclosure agreement with the disclosing party;

- the disclosure of which to third parties has been approved in advance in writing by the disclosing party; or

- the disclosure of which the disclosing party is obliged either under legislation or by court order or by official directive.

(3) The obligation to observe confidentiality shall also apply after the contractual relationship has ended.

XIII. Data Protection

The Vendor shall store and process all data relating to the Buyer obtained in connection with the contract for his own purposes observing the provisions of the German Federal Data Protection Act.

XIV. Severance Clause

Where one of the provisions of these Conditions or any other provision in any other agreement is or should become invalid or where any loophole is contained this shall not affect the validity of the remaining provisions or the contracts as a whole. Loopholes shall be filled with such valid provisions as would have been agreed by the Contracting Parties in keeping with the economic purpose of the contract and these General Conditions of Sale had they recognised the loophole in the first instance.

XV. Place of Jurisdiction, Place of Performance

As far as another exclusive place of jurisdiction does not exist, the sole and exclusive place of jurisdiction for any disputes arising out of or in connection with these Conditions (including any relating to tort claims) between the Contracting Parties shall be Bielefeld. The Vendor is however entitled to take action against the Buyer at his registered office.

Unless otherwise specified in the order confirmation, the place of performance shall be the registered office or branch office of the Vendor carrying out the respective delivery.

XVI. Applicable Law

The laws of the Federal Republic of Germany shall govern the terms of business and all legal relationships between the Buyer and the Vendor. The United Nation Convention on Contracts for the International Sale of Goods ("CISG") is excluded.

Allgemeine Verkaufsbedingungen der Parker Hannifin GmbH

I. Allgemeines

- (1) Diese Allgemeinen Verkaufsbedingungen der Parker Hannifin GmbH ("**Verkäuferin**") ("**Geschäftsbedingungen**") gelten nur gegenüber Unternehmern im Sinne von § 14 BGB ("**Käufer**") für den Verkauf von Maschinen, integrierter Software und anderen Produkten ("**Produkte**").
- (2) Angebote, Auftragsbestätigungen, Lieferungen und Leistungen der Verkäuferin erfolgen ausschließlich auf Grundlage dieser Geschäftsbedingungen.
- (3) Die Geschäftsbedingungen gelten auch für alle künftigen Geschäftsbeziehungen, auch wenn sie nicht nochmals ausdrücklich vereinbart werden.
- (4) Gegenbestätigungen des Käufers unter Hinweis auf seine Geschäfts- bzw. Einkaufsbedingungen haben auch dann keine Gültigkeit, wenn die Verkäuferin nicht ausdrücklich widersprochen hat.
- (5) Abweichungen von den vorliegenden Geschäftsbedingungen sind nur wirksam, wenn die Verkäuferin diese schriftlich bestätigt.

II. Angebot und Vertragsabschluss

- (1) Die Angebote der Verkäuferin sind freibleibend, es sei denn, sie sind ausdrücklich als verbindlich gekennzeichnet.
- (2) Der Vertrag kommt erst mit der Auftragsbestätigung durch die Verkäuferin zustande. Die Auftragsbestätigung kann schriftlich oder fernschriftlich (einschließlich EDI, Datenfernübertragung und maschinell lesbaren Datenträgern) erteilt werden. Dies gilt entsprechend für Ergänzungen, Abänderungen oder Nebenabreden. Die Rechnungsstellung gilt als Auftragsbestätigung. Angebote erfolgen unverbindlich; vor Erteilung einer Auftragsbestätigung kommt kein Vertragsabschluss zustande. Angebote bleiben für einen Zeitraum von 30 (dreißig) Tagen nach dem Datum der Ausstellung oder (andernfalls) für den im Angebot selbst angegebenen Zeitraum wirksam.
- (3) Bestell- oder Artikelnummer beziehen sich auf die jeweils neueste Ausgabe der Unterlagen der Verkäuferin wie Kataloge oder Prospekte, aus denen sich auch weitergehende technische Angaben ergeben. Diese Unterlagen sind nur annähernd maßgebend, soweit sie nicht ausdrücklich als verbindlich bezeichnet sind oder die Verwendbarkeit zum vertraglich von beiden Parteien vorgesehenen Zweck eine genaue Übereinstimmung voraussetzt. Für die genaue Einhaltung der im Katalog z. T. angegebenen Stückgewichte kann keine Gewähr übernommen werden.
- (4) Zeichnungen, Abbildungen, Maße, Gewichte oder sonstige Leistungsdaten sind nur verbindlich, wenn dies ausdrücklich schriftlich vereinbart wird. Alle Zeichnungen und Unterlagen sind bei Nichtzustandekommen des Vertrags unaufgefordert an die Verkäuferin zurückzugeben.
- (5) Wird nach Vertragsabschluss, insbesondere aufgrund offener, überfälliger Rechnungen, erkennbar, dass der Anspruch der Verkäuferin auf die Gegenleistung durch mangelnde Leistungsfähigkeit des Käufers gefährdet ist, ist die Verkäuferin berechtigt, die Erfüllung des Vertrages zu verweigern, bis der Käufer die Gegenleistung bewirkt oder Sicherheit für sie geleistet hat. Die Verkäuferin ist zum Rücktritt vom Vertrag berechtigt, wenn sie dem Käufer erfolglos eine angemessene Frist zur Bewirkung der Gegenleistung oder zur Sicherheitsleistung gesetzt hat. Etwaige Gegenrechte des Käufers bleiben unberührt.

III. Preise und Zahlungsbedingungen

- (1) Die von der Verkäuferin in ihren Angeboten angegebenen Preise sind unverbindlich, es sei denn sie sind als verbindlich gekennzeichnet. Sofern sich aus der Auftragsbestätigung nichts anderes ergibt, gelten die Preise ab Werk/Lager der Verkäuferin einschließlich Verpackung, Porto, Fracht, sonstigen Versandkosten, Versicherung und Zoll; diese werden gesondert in Rechnung gestellt. Die Verpackung wird zum Selbstkostenpreis berechnet. Die gesetzliche Mehrwertsteuer ist nicht in den Preisen der Verkäuferin eingeschlossen. Sie wird in gesetzlicher Höhe gesondert in Rechnung gestellt.
- (2) Alle Rechnungen der Verkäuferin sind 30 Tage nach Rechnungsdatum netto ohne jeden Abzug oder innerhalb von 14 Tagen nach Rechnungsdatum unter Abzug von 2 % Skonto bei Zahlstelle der Verkäuferin in Euro zahlbar. Ein Skontoabzug ist unzulässig, soweit Kaufpreisforderungen auf Grund älterer, fälliger Rechnungen noch unbeglichen sind. Eventuelle Skonti sind aus dem Rechnungsbruttobetrag zu ziehen.
- (3) Die Verkäuferin ist berechtigt, ungeachtet anderslautender Bestimmung des Käufers, Zahlungen zunächst auf dessen ältere Schulden anzurechnen. Sind bereits Kosten und Zinsen entstanden, so ist die Verkäuferin berechtigt, die Zahlung zunächst auf die Kosten, dann auf die Zinsen und zuletzt auf die Hauptleistung anzurechnen.
- (4) Eine Zahlung gilt erst dann als erfolgt, wenn der entsprechende Betrag bei der Verkäuferin eingegangen ist.
- (5) Kommt der Käufer mit seinen Zahlungsverpflichtungen in Verzug, ist die Verkäuferin nach Ablauf einer angemessenen Frist berechtigt, die gesamte Restschuld fällig zu stellen oder andere Sicherheitsleistungen zu verlangen.

IV. Aufrechnung, Zurückbehaltungsrecht, Abtretungsverbot

- (1) Der Käufer ist zur Aufrechnung und Zurückbehaltung nur im Hinblick auf Forderungen berechtigt, die unbestritten oder rechtskräftig festgestellt sind. Die Minderung aufgrund von Mängelrügen unterliegt den gleichen Einschränkungen.
- (2) Der Käufer erklärt sich mit einer Aufrechnung ihm zustehender Forderungen und Verbindlichkeiten durch die Verkäuferin und deren Konzernunternehmen einverstanden. In gleicher Weise können auch Forderungen und Verbindlichkeiten der Konzernunternehmen des Käufers verrechnet werden.
- (3) Die Rechte des Käufers aus dem Vertrag und aus diesen Geschäftsbedingungen sind nicht übertragbar.

V. Liefer- und Leistungszeit

- (1) Die von der Verkäuferin genannten Termine und Fristen sind unverbindlich, sofern nicht ausdrücklich schriftlich etwas anderes vereinbart wurde. Abruf- und Rahmenaufträge bedürfen individueller Lieferzeitvereinbarungen.
- (2) Lieferfristen beginnen an dem Tag, an dem die Bestellung des Käufers bei der Verkäuferin eingeht. Die Einhaltung der Lieferverpflichtung der Verkäuferin setzt die rechtmäßige und ordnungsgemäße Erfüllung der Verpflichtung des Käufers voraus; insbesondere müssen der Verkäuferin alle vom Käufer zu liefernden Unterlagen, Teile, Angaben und Genehmigungen vorliegen sowie etwa vereinbarte Anzahlungen geleistet worden sein.
- (3) Als Tag der Lieferung gilt der Tag, an dem die Ware dem Käufer abholbereit gemeldet wurde. Falls Versand geschuldet ist, gilt als Tag der Lieferung der Tag, an dem die Ware an die Transportperson übergeben wird.
- (4) Angemessene Teillieferungen und Teilleistungen sind in zumutbarem Umfang zulässig. Des Weiteren gelten unvermeidbare Mengenabweichungen von bis zu +/- 5 bis 10% nicht als zu geringe Menge.
- (5) Liefer- und Leistungsverzögerungen auf Grund höherer Gewalt hat die Verkäuferin nicht zu vertreten. Höhere Gewalt und Arbeitskämpfe befreien die Verkäuferin für die Dauer der Störung und im Umfang ihrer Wirkung von den Leistungspflichten. Die Verkäuferin ist verpflichtet, im Rahmen des Zumutbaren unverzüglich die erforderlichen Informationen zu geben und ihre Verpflichtungen den veränderten Verhältnissen nach Treu und Glauben anzupassen.

Ein Rücktrittsrecht steht dem Käufer in diesen Fällen erst zu, wenn die vereinbarte Lieferzeit um den Zeitraum der Dauer der höheren Gewalt zuzüglich einer angemessenen Anlaufzeit überschritten ist. Vorher besteht das Rücktrittsrecht nur, wenn die Verkäuferin dem Käufer schriftlich mitgeteilt hat, dass die Lieferung durch sie nicht oder nicht mehr erbracht werden kann. Vorstehende Einschränkung gilt nicht für Fixgeschäfte.

- (6) Gerät die Verkäuferin mit der Lieferung bei schriftlich vereinbartem Liefertermin in Verzug, so kann der Käufer vom Vertrag zurücktreten, wenn er der Verkäuferin eine angemessene Nachfrist von mindestens 14 Tagen gesetzt hat, soweit nicht ausnahmsweise eine Fristsetzung entbehrlich ist.

Erklärt der Käufer nicht bereits während der Dauer der Nachfrist, ob er weiter auf Erfüllung besteht oder von seinem Rücktrittsrecht Gebrauch machen möchte und geht eine solche Erklärung auch nicht innerhalb einer weiteren Frist von 7 Tagen bei der Verkäuferin ein, ist die Verkäuferin ihrerseits berechtigt, vom Vertrag zurückzutreten. Das Recht des Käufers gemäß Abschnitt X. Schadensersatz zu verlangen, bleibt unberührt.

VI. Gefahrübergang

- (1) Die Gefahr geht auf den Käufer über, sobald die Ware das Werk der Verkäuferin, ein Außenlager oder bei direkter Lieferung nicht selbst hergestellter Ware, das Lager des Unterlieferanten verlassen hat. Falls der Versand oder die Abholung ohne Verschulden der Verkäuferin verzögert oder unmöglich wird, geht die Gefahr mit der Meldung der Versandbereitschaft auf den Käufer über.

- (2) Angelieferte Gegenstände sind, auch wenn sie unwesentliche Mängel aufweisen, vom Käufer unbeschadet der Rechte aus Abschnitt VIII. entgegenzunehmen.

siehe nächste Seite

VII. Eigentumsvorbehalt

- (1) Die gelieferte Ware bleibt Eigentum der Verkäuferin bis der Käufer die gesamten Verbindlichkeiten aus der bestehenden Geschäftsverbindung getilgt hat.
- (2) Verarbeitung und Umbildung erfolgen stets für die Verkäuferin als Herstellerin, jedoch ohne Verpflichtung für sie. Erlischt das Miteigentum der Verkäuferin durch Vermischung, so wird bereits jetzt vereinbart, dass das Miteigentum des Käufers an der einheitlichen Sache in Höhe des Rechnungswerts wertanteilmäßig auf die Verkäuferin übergeht. Der Käufer verwahrt das Eigentum oder Miteigentum der Verkäuferin unentgeltlich.
- (3) Der Käufer verpflichtet sich, das Eigentum/Miteigentum der Verkäuferin mit der Sorgfalt eines ordentlichen Kaufmanns vor Verderb, Wertminderung oder Verlust zu bewahren, auch gegenüber seinen Käufern.
- (4) Der Käufer ist berechtigt, die Vorbehaltsware im ordnungsgemäßen Geschäftsverkehr zu verarbeiten und zu veräußern. Verpfändung oder Sicherungsübereignung sind unzulässig. Die aus dem Weiterverkauf oder einem sonstigen Rechtsgrund bezüglich der Vorbehaltsware entstehenden Forderungen tritt der Käufer bereits jetzt sicherungshalber in vollem Umfang und mit allen Nebenrechten an die Verkäuferin ab.
- (5) Bei Zugriffen Dritter auf die Vorbehaltsware wird der Käufer auf das Eigentum der Verkäuferin hinweisen und diese unverzüglich benachrichtigen. Kosten und Schäden trägt der Käufer.
- (6) Bei Zahlungsverzug des Käufers ist die Verkäuferin berechtigt, vom Vertrag zurückzutreten und die Vorbehaltsware auf Kosten des Käufers zurückzunehmen oder gegebenenfalls Abtretung der Herausgabeansprüche des Käufers gegen Dritte zu verlangen. Das Recht der Verkäuferin, Schadensersatz zu verlangen, bleibt unberührt. Das gleiche gilt bei sonstigem vertragswidrigem Verhalten des Käufers.
- (7) Die Verkäuferin verpflichtet sich, die ihr zustehenden Sicherheiten auf Verlangen des Käufers insoweit freizugeben, als der realisierbare Wert ihrer Sicherheiten die zu sichernden Forderungen um mehr als 20% übersteigt. Die Auswahl der freizugebenden Sicherheiten obliegt ihr.

VIII. Ansprüche wegen Mängeln

- (1) Die Verkäuferin haftet dafür, dass ihre Produkte frei von Fabrikations- und Materialmängeln sind und im übrigen die in der Auftragsbestätigung vorgesehenen Eigenschaften aufweisen. Vorbehaltlich von den in diesen Geschäftsbedingungen vorgesehenen oder gesetzlichen Regelungen übernimmt die Verkäuferin keine weiteren ausdrücklichen oder konkludenten Garantien, insbesondere nicht für eine Qualität mittlerer Art und Güte, oder für eine Eignung für einen bestimmten Zweck. Garantien werden von der Verkäuferin nur eingeräumt, wenn diese ausdrücklich und schriftlich als Garantie bezeichnet worden ist. Ansprüche des Käufers wegen Mängeln setzen voraus, dass dieser seinen nach § 377 HGB geschuldeten Untersuchungs- und Rügepflichten ordnungsgemäß nachgekommen ist.
- (2) Bei Produkten mit integrierter Software kommt hinsichtlich der Software ein separater Kaufvertrag zustande. Ein Mangel an dieser Software stellt keinen Mangel an dem übrigen Produkt dar, es sei denn, das übrige Produkt entspricht durch den Mangel an der Software nicht der zwischen Verkäuferin und Käufer vereinbarten Beschaffenheit. Wenn eine solche Beschaffenheit nicht vereinbart worden ist, stellt ein Mangel an der Software nur dann ein Mangel an dem übrigen Produkt dar, wenn sich das übrige Produkt aufgrund des Softwaremangels nicht für die vertraglich vorausgesetzte oder gewöhnliche Verwendung eignet.
- (3) Branchenübliche Abweichungen sind nur dann als Mangel anzusehen, wenn dies von den Parteien ausdrücklich schriftlich vereinbart wurde. Die Angaben der Verkäuferin zum Liefer- und Leistungsgegenstand in ihren Katalogen, Prospekten und Preislisten stellen lediglich Beschreibungen, Kennzeichnungen oder Richtwerte dar, soweit sich aus der Auftragsbestätigung oder aus dem von beiden Parteien vereinbarten vertraglich vorgesehenen Zweck nicht etwas anderes ergibt. Geringfügige, unerhebliche Abweichungen gegenüber den Katalogen oder früher gelieferten Waren gelten nicht als Mängel.
- (4) Der Käufer hat selbst zu prüfen, ob die bei der Verkäuferin bestellte Ware sich für die von ihm beabsichtigten Verwendungszwecke eignet. Die nicht geeignete Ware gilt nur dann als mangelhaft, wenn die Verkäuferin dem Käufer die Eignung schriftlich bestätigt hat.
- (5) Die Abnutzung von Verschleißteilen im Rahmen einer verkehrsüblichen Benutzung stellt keinen Mangel dar.
- (6) Werden Montage, Einbau, Betriebs- oder Wartungsanweisungen der Verkäuferin nicht befolgt, Änderungen an den Produkten vorgenommen, Teile ausgewechselt oder Verbrauchsmaterialien verwendet, die nicht den Originalspezifikationen entsprechen, bestehen Mängelansprüche nur dann, wenn der Käufer den Nachweis erbringt, dass der Mangel nicht hierdurch verursacht worden ist, sondern bereits bei Gefahrübergang vorlag.
- (7) Wurde die Ware noch nicht an einen Endverbraucher geliefert, verpflichten begründete und ordnungsgemäß gerügte Mängel die Verkäuferin nach ihrer Wahl, die Mängel durch Nachbesserung zu beseitigen oder den Liefergegenstand oder Teile davon neu zu liefern. Schlägen Nachlieferungen oder -besserungen fehl, so kann der Käufer nur Herabsetzung der Vergütung verlangen oder nach seiner Wahl vom Vertrag zurücktreten. Das Rücktrittsrecht und ein Anspruch auf Schadensersatz statt der ganzen Leistung bestehen nur, soweit der Mangel nicht unerheblich ist. Das Recht des Käufers, Schadensersatz geltend zu machen, richtet sich nach Abschnitt X.
- (8) Wurde die Ware bereits an einen Endverbraucher geliefert, ist der Käufer grundsätzlich nur berechtigt, jene Mängelansprüche gegenüber der Verkäuferin geltend zu machen, die sein Abnehmer ihm gegenüber geltend gemacht hat. Mängelansprüche können gegenüber der Verkäuferin nicht geltend gemacht werden, soweit die Ware aufgrund mit der Verkäuferin nicht abgestimmten Kulanzregelungen zurückgenommen wurde. Darüber hinaus ist der Käufer der Verkäuferin gegenüber zum Rücktritt nicht berechtigt, wenn er die Ware deswegen zurücknehmen musste, weil er seiner Pflicht zur Nacherfüllung nicht ordnungsgemäß nachgekommen ist, insbesondere weil er eine ihm gesetzte Frist zur Nacherfüllung fruchtlos hat verstreichen lassen. Der Käufer hat die Verkäuferin vorher unverzüglich schriftlich von dem Nacherfüllungsverlangen seines Abnehmers in Kenntnis zu setzen und ihr die beabsichtigte Art der Nacherfüllung sowie die ungefähren damit verbundenen Kosten mitzuteilen. Der Käufer ist gehalten, im Interesse der Verkäuferin die Summe der Aufwendungen im Sinne des § 439 Abs. 2 BGB so gering wie möglich zu halten und entsprechenden Vorschlägen der Verkäuferin, die eine günstigere Variante der Nacherfüllung vorsehen, nachzukommen.
- (10) Verletzt die Verkäuferin nicht leistungsbezogene Pflichten gem. § 241 Abs. 2 BGB, so steht dem Käufer ein Rücktrittsrecht und ein Anspruch auf Schadensersatz statt der Leistung dann zu, wenn dem Käufer das Festhalten am Vertrag nicht mehr zuzumuten ist.
- (11) Dann müsst Ihr leider warten, kich kann nicht Im Falle der Mängelbeseitigung ist die Verkäuferin verpflichtet, alle zum Zweck der Mängelbeseitigung erforderlichen Aufwendungen, insbesondere Transport-, Wege-, Arbeits- und Materialkosten zu tragen, sofern und soweit sie nicht darauf beruhen, dass die Kaufsache nach einem anderen Ort als dem Erfüllungsort verbracht wird.
- (12) Ansprüche wegen Mängeln verjähren innerhalb von 12 Monaten ab Ablieferung der Sache beim Käufer. Für Fälle des Vorsatzes oder der Fahrlässigkeit gilt Ziffer X.

IX. Software

Die Software der Verkäuferin ist nicht für den privaten Gebrauch bestimmt. Sie darf nur durch qualifiziertes Personal, das mit den Informationen der Verkäuferin in den Installations- und Warnhinweisen vertraut ist, installiert und/oder genutzt werden.

Eine fehlerhafte Installation, Bedienung und/oder Wartung der Software durch den Käufer können dazu führen, dass die Software nicht einwandfrei funktioniert und/oder Schäden an Anlagen und/oder Maschinen oder Menschen hervorruft.

Wenn und soweit Mängel an der Software auf einer Nichteinhaltung der Installations- und Warnhinweise der Verkäuferin und/oder auf einer fehlerhaften Bedienung und/oder Wartung der Software durch den Käufer beruhen, fallen diese nicht unter die Gewährleistungspflichten der Verkäuferin. Ebenso übernimmt die Verkäuferin keine Haftung für daraus resultierende Folgeschäden. Dies gilt insbesondere für etwaige, aus der fehlerhaften Software entstehende Schäden an der Software und/oder Folgeschäden an Maschinen, Anlagen oder anderen Produkten und Menschen.

X. Haftungsbeschränkung

- (1) Die Verkäuferin haftet unbeschränkt bei Vorsatz und grober Fahrlässigkeit, bei schuldhafter Verletzung von Leben, Körper, Gesundheit, bei Mängeln, die die Verkäuferin arglistig verschwiegen hat, oder bei der Abgabe einer Beschaffenheits- oder Haltbarkeitsgarantie. Die Verkäuferin haftet ebenfalls unbeschränkt im Rahmen der Produkthaftung sowie im Rahmen anderer zwingender Haftungsvorschriften.
- (2) Bei schuldhafter Verletzung wesentlicher Vertragspflichten haftet die Verkäuferin auch bei einfacher Fahrlässigkeit, jedoch begrenzt auf den vertragstypischen, vernünftigerweise bei Vertragsabschluss vorhersehbaren Schaden. Wesentliche Vertragspflichten sind solche, bei deren Verletzung der Vertragszweck gefährdet wird, weil dem Käufer dadurch Rechte genommen oder solche Rechte beschränkt werden, die ihm von

siehe nächste Seite

XI. Nutzungs- und Verwertungsrecht, Schutzrechte

(1) Soweit die Verkäuferin aufgrund einer Bestellung des Käufers nach dessen Anweisungen und Richtlinien Ware herstellt und an den Käufer liefert, haftet der Käufer der Verkäuferin im Rahmen seines Verschuldens für die Freiheit der in Auftrag gegebenen Lieferungen und Leistungen von Schutzrechten Dritter. Er stellt die Verkäuferin in diesem Umfang von allen entsprechenden Ansprüchen frei und hat ihr den entstandenen Schaden zu ersetzen.

(2) Soweit die Verkäuferin dem Käufer Werkzeuge, Entwürfe, Einbauvorschläge oder sonstige Zeichnungen und Unterlagen zusammen mit der Ware zur Verfügung stellt, behält sie sich hieran das Eigentum und alle Schutz- und Nutzungsrechte vor. Der Käufer ist nur zur Nutzung im Rahmen des Kaufvertrages berechtigt; er ist insbesondere nicht berechtigt, solche Gegenstände zu vervielfältigen oder sie Dritten zugänglich zu machen.

(3) Soweit es sich bei den Produkten um integrierte Software handelt, ist der Käufer zu deren Nutzung im vertraglich vereinbarten Umfang berechtigt. Die geistigen Eigentumsrechte an der Software sowie an eventuell mitgelieferten Handbüchern bleiben unberührt. Der Kunde darf die Software sowie die Handbücher nur im gesetzlich zwingend vorgesehenen Rahmen vervielfältigen oder Dritten zugänglich machen. Die §§ 69 a ff. Urhebergesetz (UrhG) bleiben unberührt. Die Verkäuferin übernimmt keine Gewährleistung und/oder Haftung für die Software, wenn und soweit diese vom Kunden geändert oder nicht ordnungsgemäß benutzt wird.

XII. Geheimhaltung

(1) Falls nicht ausdrücklich schriftlich anders vereinbart, gelten alle im Zusammenhang der Vertragsbeziehung vom Käufer erlangten Informationen als vertraulich.

(2) Die Geheimhaltungspflicht gilt nicht für Informationen, die der Partei, die die Informationen erhalten hat ("**empfangende Partei**") nachweislich bereits vor der Offenlegung bekannt waren, vorausgesetzt, dass die empfangende Partei dies der Partei, die die Informationen offengelegt hat ("**offenlegende Partei**") innerhalb eines Monats nach Empfang solcher Informationen mitteilt;

- die im Zeitpunkt ihrer Offenlegung gegenüber der empfangenden Partei bereits öffentlich bekannt oder zugänglich sind oder nach der Offenlegung öffentlich bekannt oder zugänglich werden, ohne dass dies auf einer Verletzung dieses Vertrages durch die empfangende Partei beruht;

- die die empfangende Partei von Dritten erlangt, vorausgesetzt, dass diese Informationen nicht Inhalt einer Vertraulichkeitsvereinbarung mit der offenlegenden Partei sind;

- deren Weitergabe an Dritte von der offenlegenden Partei vorher schriftlich gestattet worden ist; oder

- bezüglich derer die offenlegende Partei gesetzlich oder durch gerichtliche oder behördliche Anordnung zur Offenlegung verpflichtet ist.

(3) Die Verpflichtung zur Geheimhaltung gilt auch über die Beendigung des Vertragsverhältnisses hinaus.

XIII. Datenschutz

Die Verkäuferin wird alle im Zusammenhang mit der Vertragsabwicklung erhaltenen Daten über den Käufer unter Beachtung der Vorschriften des Bundesdatenschutzgesetzes für eigene Zwecke speichern und verarbeiten.

XIV. Teilwirksamkeit

Sollte eine Bestimmung in diesen Geschäftsbedingungen oder eine Bestimmung im Rahmen sonstiger Vereinbarungen unwirksam sein oder werden oder eine Lücke enthalten, so wird hiervon die Wirksamkeit aller sonstigen Bestimmungen oder Vereinbarungen nicht berührt. Zur Ausfüllung der Lücken gelten diejenigen wirksamen Regelungen als vereinbart, welche die Vertragspartner nach den wirtschaftlichen Zielsetzungen des Vertrages und dem Zweck dieser Allgemeinen Verkaufsbedingungen vereinbart hätten, wenn sie die Regelungslücke erkannt hätten.

XV. Gerichtsstand, Erfüllungsort

Ausschließlicher Gerichtsstand für alle sich aus oder im Zusammenhang mit diesen Geschäftsbedingungen ergebenden Streitigkeiten (einschließlich solcher über deliktsrechtliche Ansprüche) zwischen den Parteien für die kein anderer, ausschließlicher Gerichtsstand besteht, ist Bielefeld. Die Verkäuferin ist jedoch berechtigt, den Käufer auch an seinem Geschäftssitz zu verklagen.

Sofern sich aus der Auftragsbestätigung nichts anderes ergibt, ist Erfüllungsort der Geschäftssitz der Zweigniederlassung der Verkäuferin, die die jeweilige Lieferung ausführt.

XVI. Anwendbares Recht

Für die Geschäftsbedingungen und die gesamten Rechtsbeziehungen zwischen dem Käufer und der Verkäuferin gilt das Recht der Bundesrepublik Deutschland. Das Übereinkommen der Vereinten Nationen vom 11. April 1980 über den internationalen Warenkauf ("CISG") findet keine Anwendung.